

KAM
KPC-4
KPC-2400
KPC-2
KPC-1

Installation Manual

 **Kantronics**
RF Data Communications Specialists

1202 E. 23rd Street, Lawrence, Kansas 66046
Order number (913) 842-7745
Service number (913) 842-4476
9 am - noon, 2 pm - 5 pm Central Time, Monday-Friday

The KAM, KPC-4, KPC-2400, KPC-2 and KPC-1 are Kantronics hardware and software designs incorporating the AX.25 Version 2 Level 2 Packet protocol as adopted by the American Radio Relay League. This manual contains information from earlier KPC-1, KPC-2, KPC-2400, KPC-4, and KAM manuals and addendums, modified as appropriate. In addition, Kantronics acknowledges the use of material from the original Tucson Amateur Packet Radio Corporation (TAPR) TNC-1 manual granted by OEM agreement.

We have attempted to make this manual technically and typographically correct as of the date of the current printing. Production changes to the TNC may add errata or addendum sheets. We solicit your comments and/or suggested corrections. Please send to Kantronics Inc., 1202 E 23rd Street, Lawrence, KS 66046.

Printed in the U.S.A.

© Copyright 1989 by Kantronics Inc., 1202 E. 23rd Street, Lawrence, KS 66046

All rights reserved.

Contents of this publication or the firmware described herein may not be reproduced in any form without the written permission of the copyright owner.

NET/ROM is a registered trademark of SOFTWARE 2000

Commodore, C-64, C-128, and VIC-20 are trademarks of Commodore Business Machines, Inc.

TRS-80 Color Computer and TRS Model-100 are trademarks of Radio Shack, a division of Tandy Corporation

Atari 850 is a trademark of Atari Inc., a Warner Communications Company

IBM PCjr is a trademark of International Business Machines Corporation

Apple and Macintosh are registered trademarks of Apple Computer, Inc.

Installation Manual

Table of Contents

	Page
Warranty	1
Return/Repair Procedures	2
Radio Frequency Interference Statement	3
RFI Suppression	3
Precautions	4
Back Panels	5
Connecting the TNC to Your Computer	7
RS-232/TTL Jumper	7
TNC to Computer Connection.....	7
Cable Wiring	8
Other Common Computers	11
Commodore C-64, C-128 or VIC-20	11
PCjr	11
Radio Shack Color Computers	12
TRS Model-100	12
Atari 850 Interface.....	13
Connecting Your Radios	15
DB-9 Radio Connector	15
8-Pin Din Radio Connector	17
5-Pin Din Radio Connector	18
AFSK Output Level	19
KAM – AFSK Output – VHF	19
KAM – AFSK Output – HF	19
KPC-4 – AFSK Output	20
KPC-2 – AFSK Output	20
KPC-1 – AFSK Output	20
KPC-2400 – AFSK Output	21
Interfacing Hand-Held Radios	23
In Case of Difficulty	27
TNC Does Not "Sign-On" to Computer.....	27
You Are Unable to Make a "Connect"	27
Cannot Transmit on Any Port.....	28
Cannot Return to Command Mode.....	28
Kanterm Program Problems	28
TNC Won't Transmit on HF – VHF is OK.....	28
Assembly and Disassembly of the TNC	29
Hard Reset	30
Calibration/Equalization	31
Watch Dog Timers	33

TABLE OF CONTENTS

Scope Monitoring (KAM only)	35
Dumb Modem Mode (KPC-1, KPC-2 and KPC-2400 only).....	36
Performing a Loop-Back Test (KPC-4 only).....	37
Modem Disconnect (KAM and KPC-4 only).....	38
SWDETLLED Modification (KPC-1 only).....	39
Sample Terminal Programs.....	41
Specifications	45
Parts Lists, Parts Location Diagrams, Schematics	
KAM	
KPC-4	
KPC-2	
KPC-2400	

Warranty

To be sure you will receive notice of future updates or new product information, please take a moment to complete the warranty registration card and return it to us.

We do need your warranty registration on file.

Kantronics Inc. warrants each TNC to be free from defects in material and workmanship under normal use and service for a period of one year after delivery to the ultimate user. Kantronics will repair or replace the TNC at our option, at no charge, should it become defective and should our examination disclose the TNC to be defective under warranty.

This warranty shall not apply to any unit that has been subject to misuse, neglect, accident due to wiring not of our own installation, or to use in violation of instructions furnished by Kantronics. This warranty will not be extended to units that have been repaired or altered outside our facilities.

This warranty does not cover broken or cracked cases or any accessory used in connection with the TNC. This warranty is in lieu of all other warranties expressed or implied, and no representative or person is authorized to assume for Kantronics any other liability in connection with the sale of its products.

Return/Repair Procedures

Consult the limited warranty policy in this manual for the service provisions offered by Kantronics at no charge. This warranty is considered to be in force only when the customer has submitted his completed warranty registration within 10 days of purchase, and when the stipulations of the warranty have been met. Violations of warranty clauses will automatically void the warranty and service or repairs will be charged to the owner.

Service outside the warranty will be charged at the cost of parts, labor, and return shipping. Repaired units will be returned via UPS C.O.D. These C.O.D. charges can be avoided by including your VISA or MC number with your unit to be repaired. Shipping and repair may then be charged.

When service or repairs appear necessary, it may be wise to call or write Kantronics to determine if the problem can be solved without returning the unit. Should you encounter difficulty in getting your TNC to "talk" to your computer, you may wish to perform some limited checks before calling or writing. Carefully check your wiring connections to the RS-232 port. Verify your terminal baud rate. It may be useful to perform a "Hard Reset". (See Hard Reset section.)

When calling, report the product name and ask for the Amateur Radio Service Department. Should you find it necessary to call for assistance, please have the following information available:

1. The unit name and serial number (the serial number is found on the rear panel.)
2. The firmware version number (the version number is displayed with the sign-on message of the TNC.)

If possible, you should have the TNC and your computer available to perform troubleshooting operations when you call.

The Service Department telephone hours are 9 am - noon and 2 pm - 5 pm Central Time 913-842-4476, Monday through Friday.

When writing, include a clear description of the problem, unit name, computer type, computer software used and if possible a DISPLAY listing from the TNC.

Returns to the factory for refund or exchange are strictly regulated. Any return for refund or exchange must be approved by the service department.

Radio Frequency Interference Statement

This equipment complies with the limits for a Class B computing device in accordance with the specifications in Subpart J of Part 15 of the FCC rules. These specifications are designed to minimize radio frequency interference in a residential installation; however, there is no guarantee that radio or television interference will not occur in any particular installation. If this equipment does cause interference to radio or television reception, which can be determined by turning the equipment off and on when the radio or television is on, the user is encouraged to try to correct the interference by one of the following measures.

- Reorient the radio or TV receiving antenna
- Relocate the computer with respect to the receiver
- Move the computer away from the receiver
- Plug the computer into a different outlet so that the computer and the receiver are on different branch circuits.

If necessary the user should contact the dealer or an experienced radio/TV technician for additional suggestions. The user may find the following booklet prepared by the FCC helpful:

How to Identify and Resolve Radio-TV Interference Problems.

This booklet is available from the U.S. Government Printing Office, Washington, D.C., 20402 by ordering Stock No. 004-00000345-4.

RFI Suppression

In moving to the world of digital communications via computers, a new dimension of RFI may be encountered. In spite of the equipment manufacturers' diligence, each new piece of electronic equipment will react differently in each separate environment. Every amateur station will have its own unique layout, equipment variation, and antenna installations. Experience has shown that these differences are related to the total RF environment, and may be causative factors in RFI induced problems. The suggestions given here may assist in resolving RFI problems you may encounter in your "unique" station.

1. Use shielded cable for all connections between equipment.
2. Make all interconnecting cables as short as practical. A balance should be maintained between cable length and equipment proximity. At times simply moving the video monitor one foot further from an interface or other device will solve the "screen hash" problem.
3. Antenna runs should be kept away from equipment control lines and/or interconnecting cables. If it is necessary for such lines to cross each other they should do so at 90 degree angles.
4. Ground leads should be as short as possible and go to a GOOD EARTH GROUND.
5. Interconnecting cables appearing to act as radiators or antennas should be looped through a toroid. Be certain toroids, if used, are designed for the frequency in use.

Precautions

The TNC is grounded through its connections to your transceiver. Make sure your transceiver is properly grounded and your computer has equal ground potential. Follow the grounding instructions in your transceiver manual.

Cables provided with the TNC are shielded. If you decide to use other cabling, be certain it is also shielded. We do not recommend the use of unshielded RS-232 ribbon cable in the ham shack environment.

Pin 25 of the DB-25 connector on the KAM, KPC-2, and KPC-2400 has 12 volts and should never be connected to your terminal or computer output port. Pin 18 in the KPC-2 is used by factory personnel only. Under no circumstances should you connect this pin to your terminal or computer output port.

Back Panels

KAM

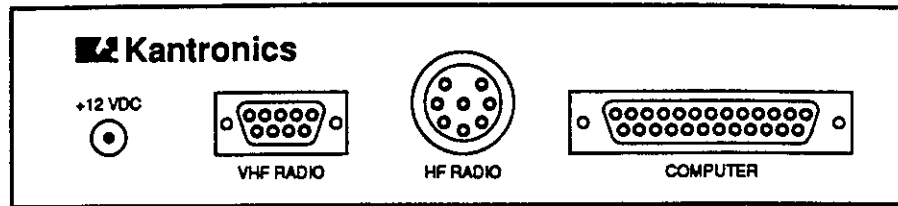

KPC-4

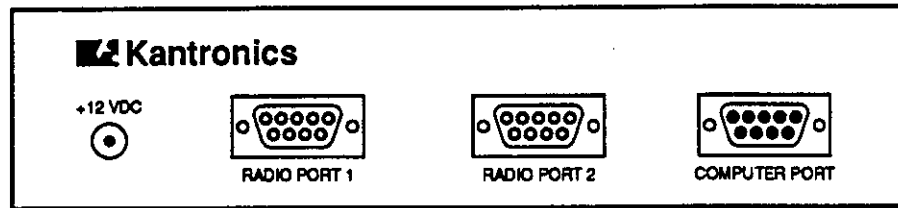

KPC-2

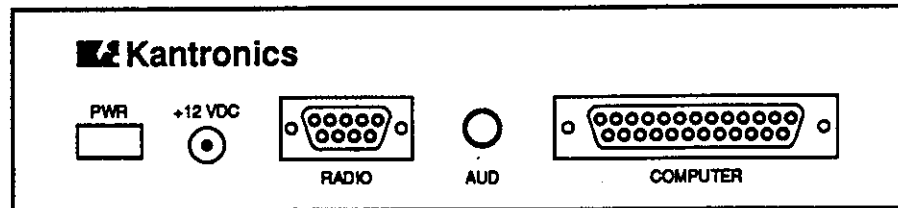

KPC-2400

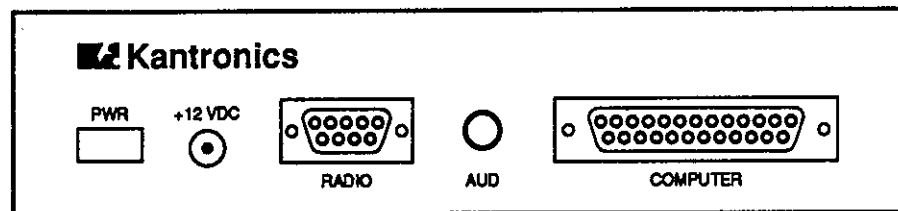

KPC-1

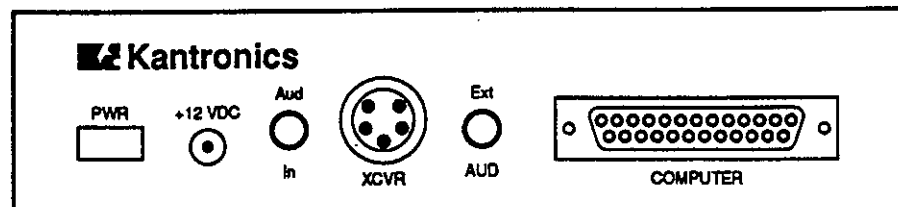

Not to exact scale.

This page left blank intentionally

Connecting the TNC to Your Computer

RS-232/TTL Jumper

Jumpers are appropriately labeled on the PC board. Refer to the parts location diagram for help in locating them. Also refer to the Assembly and Disassembly section for information on obtaining access to the interior of the TNC.

KAM Jumper K7

KPC-4 Jumper K10

KPC-2 Jumper K2

KPC-2400 Jumper K2

KPC-1 Jumper K2

This jumper is provided to change the TNC from RS-232 to TTL operating voltage levels. All TNCs are shipped from the factory in the RS-232 position. If your computer operates at TTL level voltages, reposition this jumper prior to placing the TNC in service.

TNC to Computer Connection

The TNC is connected to the serial data port of your computer and a terminal program must be loaded into your computer. The serial port provides a place for data to be sent to or received from the TNC. The terminal program is the software which runs in the computer, allowing it to communicate with the TNC. This is also sometimes called a communications program.

A few computer systems include a terminal program on the systems diskette or in the initial software package, usually named COMM, TERM, or a similar name which conveys the idea of communicating. Some computer systems require that a terminal program be obtained separately. Several simple terminal programs have been included in the Sample Terminal Programs section to assist you. In general, any program which allows telephone modem communications with the computer will be suitable for use with the TNC. A special program will be needed for the display of Wefax pictures.

There are generally four variables to be set in your terminal program. These are baud rate, parity, word length (also called data bits) and the number of stop bits. If your terminal program provides for these variables, use the following settings to talk to the TNC:

Baud rate: 300, 600, 1200, 1800, 2400, 4800 or 9600

Parity: None

Data bits: 8

Stop bits: 1

The 25-pin connector on the back panel of the TNC is for connecting to the computer. (The KPC-4 has a 9-pin connector.) When facing the back of the TNC the connector on the right side is labeled COMPUTER. See page 5 for back panel diagrams.

Cable Wiring

A cable is provided with five prewired lines for the connector. You must provide the connector to attach these lines to your computer serial port. In most cases, unless the terminal program you use requires hardware flow control, you need only connect three of these lines – Transmit Data, Receive Data and Signal Ground. For hardware flow control, also called RTS/CTS handshaking, all five wires in the provided cable are required.

Since there are so many computers on the market, it is impossible to provide interfacing information on all of them. The following chart shows what pins are used in the TNC by name and number, and the corresponding pin to connect to for the most commonly used computer connectors. As a general rule, if you have a computer not covered here that has a serial data port, wire pins of the same name together. Limited information on some of the other common computers will follow.

Transmit Data (TXD), Receive Data (RXD) and Signal Ground (SG) must always be wired in order for the TNC and the computer to exchange any data. Many terminal programs also require the use of hardware flow control from the TNC. For hardware flow control Request To Send (RTS) and Clear To Send (CTS) must also be wired. Check the documentation to your terminal program to see if any other wires are required. DO NOT CONNECT ALL 25 WIRES.

Some programs want to see Data Set Ready (DSR) to know that the TNC is there before operating. If this is the case wire both DSR and Data Terminal Ready (DTR). Or sometimes you can satisfy the program's needs by jumpering these two pins at the computer end of the cable. Data Carrier Detect (DCD) is needed by some BBS software to know that a connection has taken place. This would require wiring DCD. Some phone modem programs also want to see a connection before allowing you to even talk to the TNC. This case can usually be solved by jumpering DCD to DTR at the computer end of the cable. If your computer requires DSR and also DCD, it is perfectly acceptable to jumper all three pins (DTR, DSR, and DCD) together on the computer end of the cable. Note: DCD, DSR and DTR connections are not pre-wired in the provided cable.

The TNC is wired as DCE (Data Communication Equipment). DCE equipment always sends its data on the RXD wire. DTE (Data Terminal Equipment) talks on TXD. This means that if a computer is wired internally as DCE and attached to the TNC it will need to have TXD from the computer wired to RXD on the TNC, and RXD from the computer wired to TXD of the TNC. Otherwise they will both be talking on the same wire and never hear what is said. If properly implemented by the DCE computer, hardware flow control may be used by connecting RTS from each device to CTS on the other device.

Caution: Make sure the power to the transceivers, computer, and TNC is OFF before connecting any cables.

DB-25 Connector

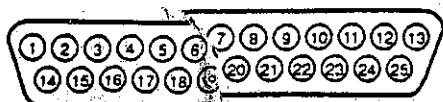

Male (Looking at Pins)



Female (Looking at Holes)

DB-9 Connector



Male (Looking at Pins)

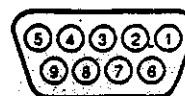

Female (Looking at Holes)

Pin Name	TNC (DCE)		Prewired Cable Color	direction	RS-232 Computer (DTE)	
	DB-25 Pin No.	DB-9 Pin No.			DB-25	DB-9
FG*	1	N/A	black	====	1	N/A
TXD	2	3	white	<====	2	3
RXD	3	2	red	====>	3	2
SG*	7	5	orange	====	7	5
RTS	4	7	green	<====	4	7
CTS	5	8	brown	====>	5	8
DCD	8	1	yellow	====>	8	1
DSR	6	6	blue	====>	6	6
DTR	20	4	purple	<====	20	4
mark	11	(KAM) To external scope, if desired				
space	18	(KAM) To external scope, if desired				
test	18	(KPC-2) DO NOT CONNECT TO COMPUTER				
+12V	25	DO NOT CONNECT TO COMPUTER				

* FG (Frame Ground) and SG (Signal Ground) are tied together in the TNC. The shield is on pin 1 of the DB-25 and on pin 5 of the DB-9. The black wire is not connected in the KPC-4 serial cable.

The functions of these lines are explained below.

DB-25 Pin 2

TXD

DB-9 Pin 3

Transmit Data. This line is the serial data from the terminal which is to be transmitted to the other station by the TNC. It is this line which is used for all communication from your terminal to the TNC, including commands.

DB-25 Pin 3

RXD

DB-9 Pin 2

Receive Data. This line is used by the TNC to send the data it receives from the other station to your terminal. This line is also used to send TNC messages to your terminal.

DB-25 Pin 7 and 1

SG

DB-9 Pin 5

Signal Ground. This line establishes the common reference potential for all circuits except Protective Ground.

DB-25 Pin 4

RTS

DB-9 Pin 7

Request To Send. This line tells the TNC that the terminal is ready to receive data. An ON level tells the TNC it may send data while an OFF level tells it to stop sending data. If the terminal for any reason is unable to accept data from the TNC, it will cause this line to change to an OFF state, providing that the terminal supports hardware flow control. For instance, buffer is full, terminal is turned off, and so on.

DB-25 Pin 5

CTS

DB-9 Pin 8

Clear To Send. This line is used by the TNC to tell the terminal whether or not it may send data to the TNC. An ON level tells the terminal it may send data while an OFF level tells it to stop sending data. This pin is the complement to the RTS pin, implementing hardware flow control in the other direction.

DB-25 Pin 8

DCD

DB-9 Pin 1

Data Carrier Detect. This line is an output from the TNC indicating connected status of the TNC. When a connection exists on the current stream, this line will be true. (When using TTL levels, DCD at +5 volts indicates connected status.) This pin has no function in the KPC-1.

DB-25 Pin 6

DSR

DB-9 Pin 6

Data Set Ready. Some terminal programs look at this pin to see that the TNC is operating before allowing you to talk to the TNC. This pin is pulled true and is common with DTR, as shipped from the factory. In the KPC-1 DSR is jumpered to DTR and is not connected to any internal circuitry.

DB-25 Pin 20

DTR

DB-9 Pin 4

Data Terminal Ready. This pin is common with DSR in the TNC. The TNC assumes the terminal is operating and does not require the terminal to pull this pin true. This pin may be isolated from DSR if desired. In the KPC-1 DTR is jumpered to DSR and is not connected to any internal circuitry.

DB-25 Pins 11/18

Mark/Space

KAM ONLY

Mark/Space. These signals are available for connecting an external scope if desired. Refer to the Scope Monitoring section for instructions.

DB-25 Pin 18

Test

KPC-2 ONLY

Processor Test Input. This is used by factory personnel only in repair and service operations. **UNDER NO CIRCUMSTANCES** should you connect this pin to your terminal or computer output port.

DB-25 Pin 25

Plus 12 Volts

KAM, KPC-2 and KPC-2400

+12V. This is an alternate input pin for supplying power to the TNC if desired. If the normal +12 VDC input jack is used, this pin will be **HOT. BE CERTAIN THIS PIN IS NOT CONNECTED TO YOUR COMPUTER.**

10. CONNECT COMPUTER

Version 3.0 Sept. 12, 1991
Installation Manual

© Copyright 1989, 1991, Kantronics, Inc. All Rights Reserved.
Duplication of this manual or the firmware without
permission of Kantronics, Inc. is prohibited.

Other Common Computers

If you have a C-64, C-128, VIC-20, PCjr, Radio Shack Color Computer, TRS Model 100, or an Atari 850, some limited information follows. For a description of the functions of the TNC pins refer to the previous information.

Commodore C-64, C-128 or VIC-20

If you are using an RS-232 adapter follow the previous instructions for Cable Wiring. If you are not using an RS-232 adapter, remember to change the TNC's RS-232/TTL Internal Jumper from RS-232 to TTL (see beginning of this chapter). Many programs will only require TXD, RXD and SG. If using hardware flow control RTS and CTS will also be required.

Commodore User Port

24 pin Double-Sided
Card Edge Connector

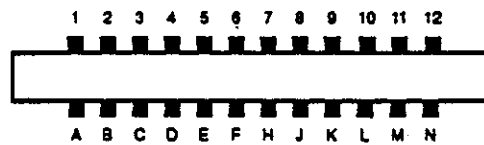

Looking at Back of computer or
Back (wiring side) of connector

Pin Name	TNC (DCE) DB-25 Pin No.	DB-9 Pin No.	Prewired Cable Color	direction	Commodore User Port (TTL) Pin Id
TXD	2	3	white	<===	M
RXD	3	2	red	===>	B & C
SG	7/1	5	orange	====	N
RTS	4	7	green	<===	D
CTS	5	8	brown	===>	K
DCD	8	1	yellow	===>	H
DSR	6	6	blue	===>	L
DTR	20	4	purple	<===	E
mark	11	(KAM) To external scope, if desired			
space	18	(KAM) To external scope, if desired			
test	18	(KPC-2) DO NOT CONNECT TO COMPUTER			
+12V	25	DO NOT CONNECT TO COMPUTER			

PCjr

The IBM PCjr has a built-in terminal program in the basic cartridge. The terminal mode is started by typing TERM. Consult the PCjr Technical Reference Manual for pin-out requirements for the PCjr serial port. You will have to buy a special connector from your computer dealer for the PCjr.

Radio Shack Color Computers

The serial port of the color computer uses a 4-pin DIN plug. Pin connections at the port are shown in the pin table below.

Pin Name	TNC DB-25	KPC-4 DB-9	Cable Color	TRS CoCo
TXD	2	3	white	4
RXD	3	2	red	2
SG	7	5	orange	3

This is known as a three-wire interface and therefore requires the use of software flow control. This cabling supports the TRS VIDTEX program. If you have a micro-color computer, such as the MC-10, cabling is different; consult your computer reference manual.

You may also use the Radio Shack Deluxe RS-232 Program Pak. This is a plug-in module for the TRS-80 Color Computer line which is available from Radio Shack Stores.

The Deluxe RS-232 Pak has a standard DB-25 serial port connector to which you connect the TNC using the following pin configurations:

Pin Name	TNC DB-25	KPC-4 DB-9	Cable Color	TRS RS-232
TXD	2	3	white	2
RXD	3	2	red	3
SG	7	5	orange	7

You must also install a jumper between pin 8 and pin 20 on the DB-25 connector of the Deluxe RS-232 Pak. It is not necessary to connect RTS/CTS lines. Since these lines are not connected, you must use software flow control. Configure the Deluxe RS-232 Pak as outlined in its operation manual, select the Terminal Mode and you will be ready for packet operation.

TRS Model-100

This computer has a standard RS-232 serial port using a DB-25 connector wired as DTE. The internal modem program DOES NOT support CTS/RTS hardware flow control. Be sure to have the TNC command XFLOW ON so that software flow control (XON/XOFF) will be used. You should make a three-wire cable as follows:

Pin Name	TNC DB-25	KPC-4 DB-9	Cable Color	TRS-100
TXD	2	3	white	2
RXD	3	2	red	3
SG	7	5	orange	7

Atari 850 Interface

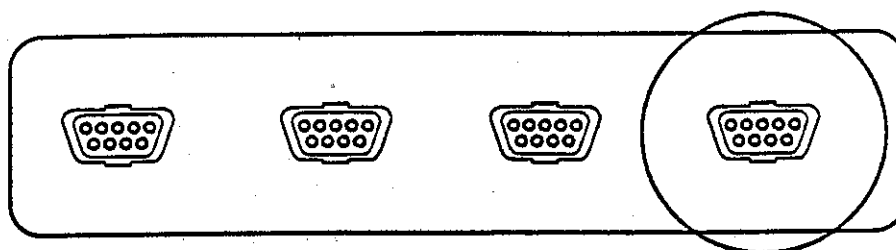

Looking at socket from outside of Interface

Pin functions of Serial Port No. 1 in 850 Interface Module 9-pin female connector:

Pin Name	TNC DB-25	KPC-4 DB-9	Cable Color	Atari 850 Interface
TXD	2	3	white	3
RXD	3	2	red	4
SG	7	5	orange	5
RTS	4	7	green	7
CTS	5	8	brown	8

This page left blank intentionally

Connecting Your Radios

The TNC is attached to your transceiver(s) via the radio connector(s) on the back panel. (See page 5 for back panel diagrams.) The KPC-2 and KPC-2400 each have one DB-9 connector labeled RADIO, which is used for either VHF or HF. The KPC-1 has one 5-pin din connector labeled RADIO, which is used for either VHF or HF. The KAM has a DB-9 connector labeled VHF RADIO and an 8-pin din connector labeled HF RADIO. The KPC-4 has two DB-9 connectors for VHF/UHF radio connections labeled PORT 1 and PORT 2.

Prewired cables are provided with the appropriate connector for the TNC port. Two cables come out of the connector. One with a speaker plug attached, to be plugged into the transceiver's external speaker jack. You will need to provide the mic-jack connector for your transceiver and wire the connector to the other cable. Lines from this connector are used to control the PTT function of the transceiver, input AFSK tones from the TNC, and provide other alternate Inputs/Outputs as described. The KPC-1 comes with two separate cables. One for audio with speaker plugs on both ends. The other cable has a 5-pin din connector on the end for the KPC-1, and you will need to provide the mic-jack connector for your transceiver and wire it to the other end of this cable.

Some radios may require adjustment of the AFSK Output Levels or Equalization of the received signals. See the AFSK Output Level and Calibration/Equalization sections for information.

Caution: Check your transceiver manual to correctly wire the corresponding pins of the transceiver mic-jack.

DB-9 Radio Connector

DB-9 Connector



Male (Looking at Pins)



Female (Looking at Holes)

Pins 1, 3, 5 and 6 must be connected to your radio.

Pin 1 – AFSK Out – white lead. This line carries the AFSK tones generated by the TNC to the Audio Input (microphone) line of your transceiver. If your transceiver provides a DC voltage on its microphone input, you must isolate this voltage from the TNC. This is normally true for hand-held radios. (See the Interfacing Hand-Held Radios section.)

Pin 2 – XCD – yellow lead. This line may be used to connect the squelch line from your VHF transceiver if desired. This connection will not normally be required, nor used, unless operating on a shared voice channel. Normally the TNC detects other signals by using its internal software to determine if data is present. If this pin is connected, a ground potential on this pin will tell the TNC that a signal is present (even if there is no data) and therefore prevent the TNC from transmitting until the signal is no longer present. (See the CD parameter in the Commands Manual.)

Pin 3 – Push-To-Talk – brown lead. This line controls the PTT line in your transceiver, allowing the computer to switch the transceiver from/to transmit or receive. Connect directly to the PTT line of the mic-jack connector. (See the section on Interfacing Hand-Held Radios for special notes concerning this pin.)

Pin 4 – Blue lead – KAM same as pin 5.

KPC-4, both ports, same as pin 5.

KPC-2 same as pin 6.

KPC-2400 has no connection.

Pin 5 – Audio Signal – 2 conductor audio cable, center conductor and 9-wire cable, purple conductor. This line is prewired for your use as the audio input from your transceiver external speaker jack. Do not use a headphone output from the transceiver. If you use an accessory or phone patch output, it may be necessary to provide a padding network to reduce amplitude of the signal being fed to the TNC. High level fixed outputs may have a tendency to "swamp" the TNC input circuits. Fixed output signals in excess of 50 mV should be padded.

For the KAM and KPC-4 you can plug this lead into one leg of the Y-connector cable provided in the TNC accessory bag. Plug the Y-connector cable into the external speaker jack of the transceiver. The remaining female connector on the Y-connector cable may be used for an external speaker. For the KPC-2 and KPC-2400 the audio jack on the back panel remains available for attachment of an external speaker.

Pin 6 – Ground/Shield – shield of 9-wire cable and shield of audio cable. Connect the push-to-talk ground and AFSK shield to this line. With some transceivers which do not reference PTT and audio shielding to a common ground, it may be necessary to leave the AFSK shield (braided wire) disconnected. Note: All TNC grounds are common.

Pin 7 – KPC-4 Radio Port 1 External Reset – red lead. An external reset line is provided on this pin. Applying a ground, either from a local or remote source is the same as turning on the TNC. This is only on the KPC-4 Radio Port 1.

Pin 7 – +12VDC in – red lead. This lead is provided as an alternate power input. It may be used in place of the +12 VDC jack. If you do not plan to use this alternate input you should clip the wire and insulate it. This lead will be HOT whenever the TNC is powered. This connection should not be used to power any accessory device. Note that on the KPC-4, Radio Port 2 has +12 volts on this pin whereas Radio Port 1 does not. **DO NOT INTERCHANGE CABLES CONNECTED TO THE KPC-4 if you are using this pin on either port.**

Pin 8 – Green lead – KAM same as pin 6.

KPC-4 both ports, same as pin 6.

KPC-2 no connection.

KPC-2400 no connection.

Pin 9 – Ground – Black lead – same as pin 6.

8-Pin Din Radio Connector (KAM HF)

8-Pin Din

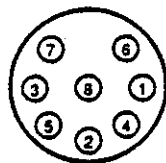

Female (Looking at Holes)

Pins 1, 2, 3 and 6 must be connected to your radio.

Pin 1 – AFSK Out – white lead. This line carries the AFSK tones generated by the KAM to the Audio Input (microphone) line of your transceiver.

Pin 2 – Ground/Shield – black and shield of 9-wire cable and shield of audio cable. Connect the push-to-talk ground and AFSK shield to this line. With some transceivers which do not reference PTT and audio shielding to a common ground, it may be necessary to leave the AFSK shield (braided wire) disconnected. Note: All TNC grounds are common.

Pin 3 – Push-To-Talk – brown lead. This line controls the PTT line in your transceiver allowing the computer to switch the transceiver from/to transmit or receive. Connect directly to the PTT line of the mic-jack connector.

Pin 4 – Key Out – orange lead. This line may be used to control CW keying on your transceiver. Separate a small length of this lead and attach a lead with the appropriate plug for your transceiver key jack, where you would normally connect a straight key.

Pin 5 – FSK Out – red lead. This line is for use if your transceiver provides FSK keying for radioteletype operation. Separate a small length of this lead and attach a lead with the appropriate plug for your FSK input connector on the transceiver. It will also be necessary to provide for PTT keying via the mic jack, accessory port or other method specified by your transceiver manual.

Pin 6 – Audio Signal – 2 conductor audio cable, center conductor and 9-wire cable, purple conductor. Plug this lead to one leg of the Y-connector cable provided in the KAM accessory bag. Plug the Y-connector cable into the external speaker jack of the transceiver. The remaining female connector on the Y-connector cable may be used for an external speaker. Do not use a headphone output from the transceiver. If you use an accessory or phone patch output, it may be necessary to provide a padding network to reduce amplitude of the signal being fed to the KAM. High level fixed outputs may have a tendency to "swamp" the KAM input circuits. Fixed output signals in excess of 50 mV should be padded.

Pin 7 – Blue lead – This pin is not connected in the KAM but the blue conductor of the 9-wire cable is attached to this pin.

Pin 8 – XCD – yellow lead. This line may be used to connect the squelch line from your HF transceiver if desired. This connection will not normally be required, nor used, unless operating on a shared voice channel. (See the CD parameter in the Commands Manual.)

5-Pin Din Radio Connector (KPC-1 - Packet Communicator)

5-Pin Din

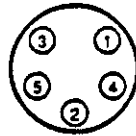

Female (Looking at Holes)

Pins 1, 2, 3, and Audio In must be connected to your radio.

Pin 1 - AFSK Out - white lead. This line carries the AFSK tones generated by the TNC to the Audio Input (microphone) line of your transceiver. If your transceiver provides a DC voltage on its microphone input, you must isolate this voltage from the TNC. This is normally true for hand-held radios. (See the Interfacing Hand-Held Radios section.)

Pin 2 - Ground/Shield - black and stranded lead. Connect the push-to-talk ground and AFSK shield to this line. With some transceivers which do not reference PTT and audio shielding to a common ground, it may be necessary to leave the AFSK shield (braided wire) disconnected. Note: All TNC grounds are common.

Pin 3 - Push-To-Talk - Brown lead. This line controls the PTT line in your transceiver allowing the TNC to switch the transceiver from/to transmit or receive. Connect directly to the PTT line of the mic-jack connector. (See the section on Interfacing Hand-Held Radios for special notes concerning this pin.)

Audio in - Attach a cable from the external speaker jack of the transceiver to the Audio In jack on the rear panel of the Packet Communicator. Do not use a headphone or phone patch output from your transceiver.

External Speaker Jack - This jack can be used to loop the audio through the Packet Communicator. Use a 3.5 mm plug and shielded audio cable to connect to an external speaker.

AFSK Output Level

Audio Frequency Shift Keying

Jumpers are appropriately labeled on the PC board. Refer to the parts location diagram for help in locating them. Also refer to the Assembly and Disassembly section for information on obtaining access to the interior of the TNC.

KAM - AFSK Output - VHF - Jumper K2

This jumper is provided to alter the VHF AFSK output level. The KAM is shipped from the factory with the jumper in the LO position. The LO position sets an AFSK output level from the KAM at 10 mV. The HI position sets an AFSK output level of 50 mV. Both levels are peak-to-peak values. In general, transceivers requiring a pre-amplified microphone will also require the HI level AFSK output from the KAM. Removing the jumper entirely will provide the maximum possible output level of approximately 1.7 P/P volts VHF. Should you require an intermediate value of AFSK modulation signal, it may be obtained by replacing resistor R12 with the appropriate value chosen from the following chart. If you change R12 to obtain an intermediate value, place K2 in the HIGH position.

R12 Value	AFSK Output Level
470 ohms	24 mV
2.2 Kohms	106 mV
6.8 Kohms	290 mV
22 Kohms	680 mV
47 Kohms	1000 mV

KAM - AFSK Output - HF - Jumper K5

This jumper is provided to alter the HF AFSK output level. The KAM is shipped from the factory with the jumper in the LO position. The LO position sets an AFSK output of 100 mV. The HI position sets the output level at 500 mV. Both levels are peak-to-peak values. In general, transceivers requiring a pre-amplified microphone will also require the HI level AFSK output from the KAM. Removing the jumper entirely will provide the maximum possible output level of approximately 1.6 volts P/P. Should you require an intermediate value of AFSK modulation signal, it may be obtained by replacing resistor R25 with the appropriate value chosen from the following chart. If you change R25 to obtain an intermediate level, place K5 in the HIGH position.

R25 Value	AFSK Output Level
680 ohms	48 mV
3.3 Kohms	209 mV
4.7 Kohms	282 mV
6.8 Kohms	377 mV
22 Kohm	800 mV

KPC-4 – AFSK Output – Jumpers K3 and K4

These jumpers are provided to alter the AFSK output level. The KPC-4 is shipped from the factory with the jumpers in the LO position. The LO position sets an AFSK output level from the KPC-4 at 10 mV. The HI position sets an AFSK output level of 50 mV. Both levels are peak-to-peak values. In general, transceivers requiring a pre-amplified microphone will also require the HI level AFSK output from the KPC-4. Removing the jumper entirely will provide the maximum possible output level of approximately 1.7 volts. Should you require an intermediate value of AFSK modulation signal, it may be obtained by replacing resistor R23 or R29 with the appropriate value chosen from the following chart. If you change resistors to obtain an intermediate value, place the appropriate jumper in the HIGH position.

K3	K4	
Port 1	Port 2	
R23 Value	R29 Value	AFSK Output Level
470 ohms	470 ohms	24 mV
2.2 Kohms	2.2 Kohms	106 mV
6.8 Kohms	6.8 Kohms	290 mV
22 Kohms	22 Kohms	680 mV
47 Kohms	47 Kohms	1000 mV

KPC-2 – AFSK Output – Jumper K1

KPC-1 – AFSK Output – Jumper K3

This jumper is provided to alter the AFSK output level. The TNC is shipped with this jumper in the high position. In the high position output level is 21 mV P/P. In the low position output is 4.5 mV P/P. If a higher output level is required for your radio it may be obtained by changing the resistor (R14 in KPC-2, R37 in KPC-1). The chart below gives the output levels for different values of the resistor with the jumper in the HI position.

KPC-2	KPC-1	
R14 value	R37 value	AFSK level
100 ohm	100 ohm	4.5 mV
220 ohm	220 ohm	10 mV
470 ohm	470 ohm	21 mV
1 K	1 K	44 mV
1.5 K	1.5 K	65 mV
2.2 K	2.2 K	94 mV
8.2 K	8.2 K	298 mV

Should you require a still higher AFSK output level the value of the resistor may be increased further to provide incremental increases in the same approximate ratio as that shown in the table. For maximum output level the HI LO jumper can be removed entirely. In this case AFSK output level will be approximately 1.5 volts peak-to-peak.

KPC-2400 – AFSK Output – Jumper K1

This jumper is provided to alter the AFSK output level. The KPC-2400 is shipped with this jumper in the high position. In the high position output level is 44 mV P/P (open circuit, 600 ohms nominal). In the low position output is 10 mV P/P. If a higher output level is required for your radio it may be obtained by changing R32. The chart below gives the output levels (open circuit) for different values of R32 with the jumper in the HI position.

R32 value	AFSK level
100 ohm	4.5 mV
220 ohm	10 mV
470 ohm	21 mV
1 K	44 mV
1.5 K	65 mV
2.2 K	94 mV
8.2 K	298 mV

Should you require a still higher AFSK output level the value of R32 may be increased further to provide incremental increases in the same approximate ratio as that shown in the table. For maximum output level the HI LO jumper can be removed entirely. In this case AFSK output level will be approximately 1.5 volts peak-to-peak.

This page left blank intentionally

Interfacing Hand-Held Radios

Many transceivers, especially most hand-held models, obtain Push-To-Talk keying by completing a circuit between the mic input and PTT ground. A direct PTT input to the mic input line of units with this type electret condenser microphone is not usable without some type of isolation.

If you plan to operate with a hand-held transceiver, the KAM, KPC-2 and KPC-4 have incorporated an isolation circuit which is available by jumper positioning. Should you later use a different type radio, this change may need to be reconfigured. Most other radios of current manufacture will not require any modification of the TNC.

You may also interface to a hand-held without performing this modification by incorporating the same type of circuitry in the cable from your TNC to your hand-held. Ground return and speaker audio are both supplied thru the external speaker jack of your hand-held.

ICOM HT radios key the PTT by providing a low impedance path from the mic input to ground. To accomplish this, simply install a resistor (approximately 3.9K seems to be a good value) in series with the PTT wire from the TNC, and connect this to the mic input along with the AFSK line.

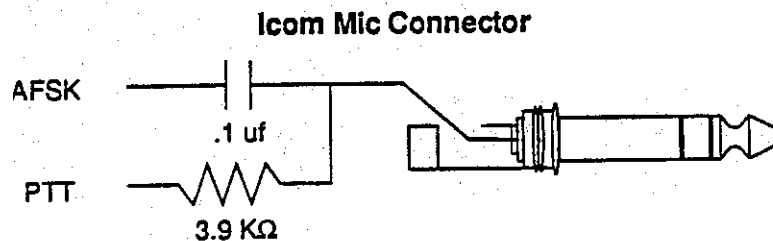

Yaesu radios are similar but use a mono plug and a different resistor.

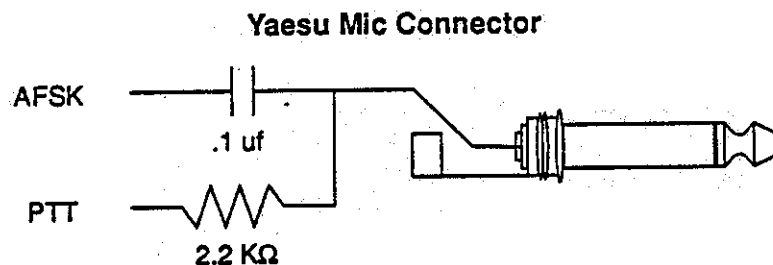

Most KENWOOD HT radios key the PTT line by connecting the sleeve of the mic connector to the sleeve of the earpiece connector. This means that you will not need a resistor in the PTT wire from the TNC, simply connect the PTT wire to the sleeve of the mic connector. Another point to watch - most of the KENWOOD HTs (2500 and later) use a three pin mic connector. The AFSK from the TNC should therefore connect to the RING and not the TIP of the mic connector.

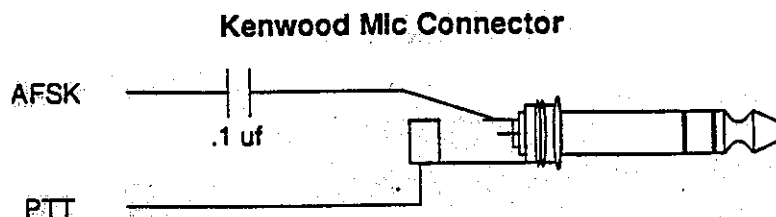

Enabling the Isolation Circuit in the KAM

1. Refer to the Assembly and Disassembly section for instructions if necessary and remove the KAM from its case.
2. Locate point Z on the PC board. This point is at the rear, near the HF radio output port and power jack.

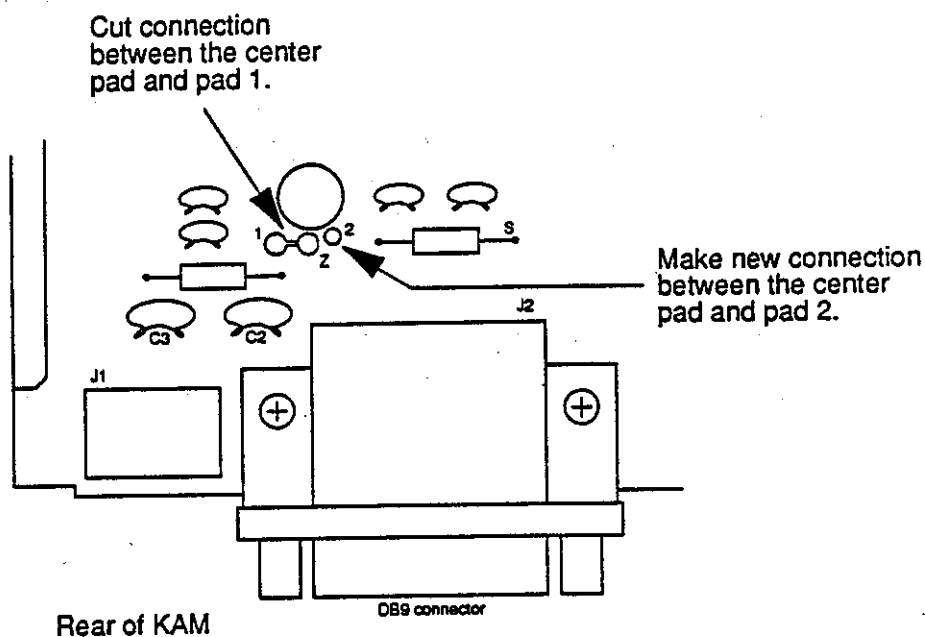

3. Locate the three pads associated with Z. Note that the center pad and the pad marked 1 is larger than the pad marked 2.
4. Carefully cut the connection between the center pad and pad 1.
5. Make a new connection between the center pad and pad 2. You may wish to make this connection on the bottom of the PC board instead of the component side.
6. Connect the AFSK and PTT lines together.

Enabling the Isolation Circuit in the KPC-2

1. Refer to the Assembly and Disassembly section for instructions if necessary and remove the KPC-2 from its case.
2. Locate jumper Q on the PC board. This location is at the rear of the PC board.

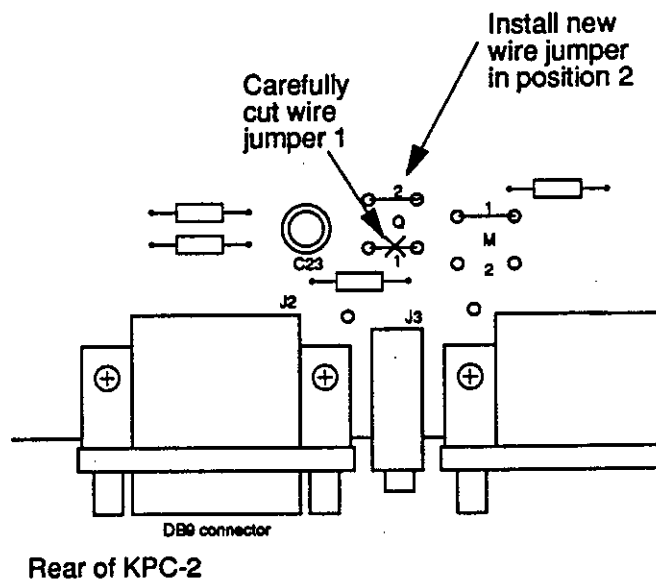

3. Locate the wire jumper marked 1.
4. Carefully cut the jumper.
5. Install a new jumper in position 2. You may wish to make this connection on the bottom of the PC board instead of the component side.
6. Connect the AFSK and PTT lines together.

Enabling the Isolation Circuit in the KPC-4

Separate circuits are provided for each radio port. Jumper X is for Port 1, Jumper Y is for Port 2.

1. Refer to the Assembly and Disassembly section for instructions if necessary and remove the KPC-4 from its case.
2. Locate point X or Y on the PC board. This location is at the rear of the PC board.

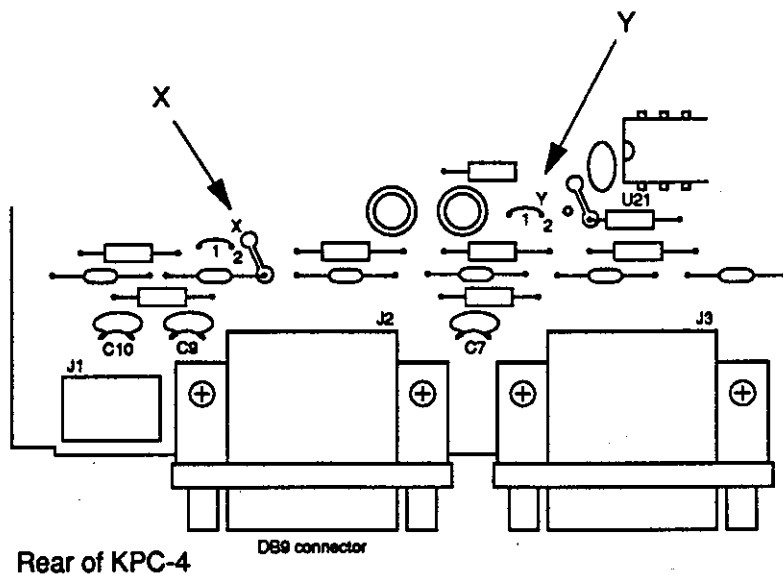

3. Locate the three points associated with X or Y. Note that there is a jumper at each of these locations which is in position 1.
4. Carefully cut the jumper.
5. Install a new jumper in position 2. You may wish to make this connection on the bottom of the PC board instead of the component side.
6. Connect the AFSK and PTT lines together.

In Case of Difficulty

Kantronics TNCs are manufactured to very stringent quality standards. If you have followed the installation procedures outlined in this manual, it is highly unlikely that you will encounter a failure. If you do have difficulty, use the procedures described in this section to assist in isolating and correcting the problem.

TNC Does Not "Sign-On" to Computer

1. Carefully recheck cabling between your computer serial port and the TNC.
2. Check carefully to insure that the Transmit Data, Receive Data, and Ground leads are connected to the proper pins.
3. If you have made a 5 wire connection to the computer serial port, change to a 3 wire connection.
4. Check your terminal program to be certain it is booted with the correct communications parameters (serial port, baud rate, parity).
5. Check to insure that the RS-232/TTL jumper is properly positioned for your computer.
6. Try a "Hard Reset" using the Test/Normal jumper. (Operate your terminal program at 300 baud when performing a hard reset.)

You Are Unable to Make a "Connect"

1. Issue a connect request and observe the XMIT LEDs. If an XMIT LED illuminates, check to insure that the radio is connected to the corresponding radio port.
2. Observe the radio to determine if it is being switched to the "Transmit" condition. If not, recheck wiring between the TNC radio port, PTT pin, and ground on the microphone jack.
3. Turn the VHF radio squelch control to "OFF" and see if the RCV LED illuminates on the packet controller. If it does not light, recheck the audio connection between your transceiver and the TNC.
4. If possible, monitor your transmitted signal with another radio. If the transmitter is keying to "Transmit" but weak or no audio is monitored, increase AFSK output as necessary using the AFSK Output jumper or a resistor change. (See the AFSK Output Level section.)

Cannot Transmit on Any Port

1. Check the 8BITCONV command. Many dumb terminals, and some Commodore programs, will not operate properly with this command turned ON. The symptoms most common for this problem are that everything seems to work fine in Command Mode, but upon entering Convers Mode, the TNC no longer seems to operate at all. Usually you cannot return to Command Mode with a Ctrl-C, pressing return does not send a packet, and it just seems like the serial cable between your computer and TNC has been unplugged.
2. Check your PARITY setting in the computer and in the TNC. These must match or else the computer may not really be sending the SENDPAC character (\$0D) to the TNC.

Cannot Return to Command Mode

1. The single most common cause of this is that the STOP character (and usually XOFF) have been inadvertently set to the same as the COMMAND character. This is usually caused by the use of the dollar sign (\$) as a streamswitch. If you use the \$, be aware that you cannot enter hex values without PASSing the dollar sign. Symptoms for this usually are that you can talk to the TNC fine in Command Mode, you can usually talk to others on the air, but you just can't get back to Command Mode. (In non-packet modes, you will find that you cannot enter any of the special Ctrl-C directives either!) With most PC terminal programs, pressing Ctrl-C will display the heart character, but you still don't get the cmd: prompt.

Kanterm Program Problems

1. The most common problems reported with the Kanterm program result from not performing the Set Parameters option from within the program. This usually occurs after upgrading your TNC to a new version of the Kantronics firmware. The cause for this is the need to do a Hard Reset after installing the new firmware, and as a result, the TNC and your Kanterm program are no longer "in sync" with each other.
2. Commodore users will normally experience this problem when first setting the TNC up with their Kanterm software. All lower case characters are hidden, only numbers and punctuation appear. Typically, this means that when you first enter your callsign, only the number appears. In reality, the TNC did receive the proper callsign, and you can correct your display by choosing the Set Parameters option from the Miscellaneous Menu.

TNC Won't Transmit on HF - VHF is OK

This problem usually is a result of attempting to switch from one port to the other by using the PORT command. The PORT command only determines which port will be the default when the TNC is first turned on, or after a reset. In order to switch from one port to the other for transmitting data, you must use the STREAMSW characters as described in Multi-Connects in the Packet section of the Operations Manual.

Assembly and Disassembly of the TNC

Should you require access to the TNC to reposition jumpers or for other purposes, disassemble as follows:

1. Turn off power to your TNC and remove all cables from the unit.
2. Using a small phillips screwdriver, remove the two front panel screws just far enough to free the panel and bezel.
3. Carefully remove the front panel and bezel.
4. Note the screw holding the voltage regulator to the metal case. Remove this screw. (Does not apply to KPC-4.)
5. Slide the PC board out of the case.

To reassemble, reverse the procedure above. Be sure to re-install the screw holding the voltage regulator to the case (not in KPC-4). Failure to do so will damage the unit as the case provides a heat sink for the voltage regulator during normal operation. Do not attach cables to the rear of the TNC without supporting the front of the PC board or having the front panel secured in place. Doing so may break the voltage regulator secured to the front of the case.

Hard Reset

The hard reset process is provided to re-initialize the TNC to its default values. This process may become necessary should operational problems be encountered or when upgrading your firmware to a new version. The readout specified in step 5 below will be legible only if your terminal baud rate is 300. At other terminal baud rates, a reset will occur. However, no display readout will be observed. This procedure is performed as follows:

- 1) Remove the PC board from the case as outlined in the Assembly and Disassembly section, above.
- 2) Locate the Test/Normal jumper which is labeled NOR T (normal-test). Jumpers are appropriately labeled on the PC board. Refer to the parts location diagram for help in locating them.

KAM Jumper K6

KPC-4 Jumper K7

KPC-2 Jumper K3

KPC-2400 Jumper K3

KPC-1 Jumper K1

- 3) Place the jumper in the test position.

- 4) Apply power to the TNC.

- 5) Observe on the computer display (your terminal program must be set at 300 baud):

EEPROM INIT OK

CHECKSUM OK

RAM OK XXXXX BYTES

REPLACE TEST JUMPER

Some TNCs will not display the REPLACE message.

If you have removed the 2404 EEPROM from your unit for any reason, the EEPROM INIT message will read:

EEPROM INIT ERROR

This is a normal indication and does not indicate a failure with your TNC.

- 6) Turn power off. Do not keep the TNC power on for more than a minute or the regulator will overheat.

- 7) Return Test/Normal jumper to the normal position.

- 8) Reassemble the TNC and return to operation.

Calibration/Equalization

The CALIBRATE command is used to assist the TNC operator in determining the need for equalization of a received signal. Since this feature is unique to Kantronics TNCs, two stations using Kantronics TNCs are necessary to utilize this command.

KAM you must have your current I/O stream on the VHF radio port.

KPC-4 uses current I/O port (will not work with an external modem).

KPC-2 The HF, HFT and CCITT commands should be OFF. Calibration is checked at 1200 baud only.

KPC-1 Tones are transmitted and received at the HBAUD setting and the frequency is specified by the HF and HFT command settings.

KPC-2400 Tones are transmitted and received at the HBAUD setting and the frequency is specified by the HF, HFT, and CCITT command settings. However calibration cannot be done at the HBAUD setting of 2400.

Once the CALIBRATE command is given, three options will appear on the terminal screen:

Calibrate Mode Press R,T, or X

Pressing X will return the TNC to the Command Mode.

Pressing T will transmit a square wave (space/mark) at the selected tones until a key is pressed.

Pressing R will measure a square wave received.

One station should be used to transmit the square wave, while the receiving station should measure and compare the space/mark square wave. The transmitting station should set the microphone level in the mid range.

Once the receiving TNC is placed in the CALIBRATE receive mode, two numbers will appear on the screen. The TNC is measuring the space/mark square wave generated by the transmitting station. For the best calibration of the receiving transceiver, set the radio tone controls so that the two given values are as close to equal as possible.

In most instances when the ratio of the numbers is within a 40/60 or 60/40 range, the packet station will function normally. A larger disparity in the tones may cause additional retries during packet operation. This ratio may be determined by the following formula:

$(N1 * 100) / (N1 + N2)$ where N1 is the number to the left of the displayed slash, and N2 is to the right of the slash. For instance, if the TNC displays 1400/1800, the ratio can be determined by:

$$(1400 * 100) / (1400 + 1800) \text{ or } 140000/3200 = 44$$

Since the total is 100, the ratio is then 44/56 and is within the 40/60 criteria.

KPC-1, KPC-2, and KPC-2400. If the ratio of the numbers exceeds 60/40, you should change the setting of the equalization command (EQUALIZE). Use the setting (ON or OFF) which results in the ratio closest to 50/50.

KAM and KPC-4. If the ratio of the numbers exceeds 60/40, you should reset the internal Equalization jumper(s) for partial equalization. If, with partial equalization these numbers are still outside the 60/40 ratio, set the Equalization jumper for NO equalization.

Jumpers are appropriately labeled on the PC board. Refer to the parts location diagram for help in locating them. Also refer to the Assembly and Disassembly section for information on obtaining access to the interior of the TNC.

KAM Jumper K1

VHF Equalization – This jumper is provided to alter the equalization characteristics of the VHF modem. The KAM is shipped with the jumper placed on ONLY ONE of the posts effectively "OFF" so that full equalization is in effect. With no jumper installed on the 3-pin header, full equalization is in effect. With the jumper connecting the center post and the post marked 1, there is no equalization. With the jumper connecting the center post and the post marked 2, partial equalization is in effect. Testing has shown that most VHF transceivers require that the input audio signal be fully equalized for best performance. Should you wish to operate the KAM in a hard wire packet line, no equalization should be in effect.

KPC-4 Jumpers K1 (Port 1) and K2 (Port 2)

Equalization – These jumpers are provided to alter the equalization characteristics of the modems. The KPC-4 is shipped with the jumper placed on ONLY ONE of the posts, effectively "OFF", so that full equalization is in effect. With no jumper installed on the 3-pin header, full equalization is in effect. With the jumper connecting the center post and the post marked 1, there is no equalization. With the jumper connecting the center post and the post marked 2, partial equalization is in effect. Testing has shown that most VHF/UHF transceivers require that the input audio signal be fully equalized for best performance. Should you wish to operate the KPC-4 in a hard wire packet line, no equalization should be in effect.

Watch Dog Timers

Jumpers are appropriately labeled on the PC board. Refer to the parts location diagram for help in locating them. Also refer to the Assembly and Disassembly section for information on obtaining access to the interior of the TNC.

KAM - VHF Timer - Jumper K3

This jumper is provided to disable the VHF watch dog timer. The timer is disabled if the jumper is installed. Time-out of the KAM will occur after approximately 2.5 minutes, un-keying the VHF PTT line. The KAM is shipped with the jumper not connecting the jumper posts; therefore, the timer is in effect.

KAM- HF Timer - Jumper K4

This jumper is provided to disable the HF watch dog timer. The timer is disabled if the jumper is installed. Time-out of the KAM will occur after approximately 2.5 minutes, un-keying the HF PTT line. The KAM is shipped with the jumper installed; therefore, the timer is not in effect.

KAM Operating Note

As shipped from the factory, the VHF watch dog timer is in effect and the HF watch dog timer is not. The HF timer is not enabled since it cannot distinguish between RTTY and Packet signals. Should you plan to operate a mode other than Packet the HF timer will limit your transmission time to approximately 2.5 minutes if it is enabled.

KPC-4 - Timers - Jumpers K5 (Port 1) and K6 (Port 2)

These jumpers are provided to disable the watch dog timers. The timer is disabled if the jumper is installed. Time-out of the KPC-4 will occur after approximately 2.5 minutes, un-keying the PTT line. The KPC-4 is shipped with the jumpers not connecting the jumper posts; therefore, the timers are in effect. Should you wish to have a SHORTER timer interval, it may be obtained by changing the appropriate resistor shown in the following chart.

K5 Port 1	K6 Port 2	Time Delay	Resistor Value
R43	R44	1.25 min	470 Kohm
R43	R44	.75 min	220 Kohm
R43	R44	.5 min	2.2 Mohm

KPC-2400

The KPC-2400 is shipped with the Optional Watch Dog circuit board installed. (This applies to units after serial number 73400. An optional circuit board may be ordered from Kantronics for units with serial numbers before 73400 and should be installed for digipeater or unattended operation.)

K1 jumper on both pins disables watch dog circuit.

If harness is unplugged from watch dog board a 2.2 K 5% 1/4 watt resistor **MUST** be inserted between pins 1 and 5 of wiring harness connector to allow normal operation. **WARNING:** A resistor larger than 1/4 watt will damage the connector.

PTT shut-off time is approximately 2 minutes.

KPC-1 and KPC-2

These TNCs do not come with a watch dog timer installed. An optional circuit board may be ordered from Kantronics and should be installed for digipeater or unattended operation.

Scope Monitoring

KAM Only

Obtaining Mark and Space Outputs

The schematic diagram of the KAM indicates that Mark and Space outputs are available on pins 11 and 18 of J4 (DB-25 connector). Provisions have been made for obtaining these outputs AFTER installing jumpers between the points provided on the PC board. This is accomplished by locating the four holes in the board marked MA and SP and adding wire jumpers between them. One pair of holes marked MA and SP are located next to the DB-25 connector (J4) and the other pair is located on the opposite end of the board. Install jumpers from MA to MA and SP to SP and Mark/Space signals will then be present at pins 11 and 18 of J4. It is advisable to install a 100 Kohm resistor in series with these lines to protect the KAM from external voltages.

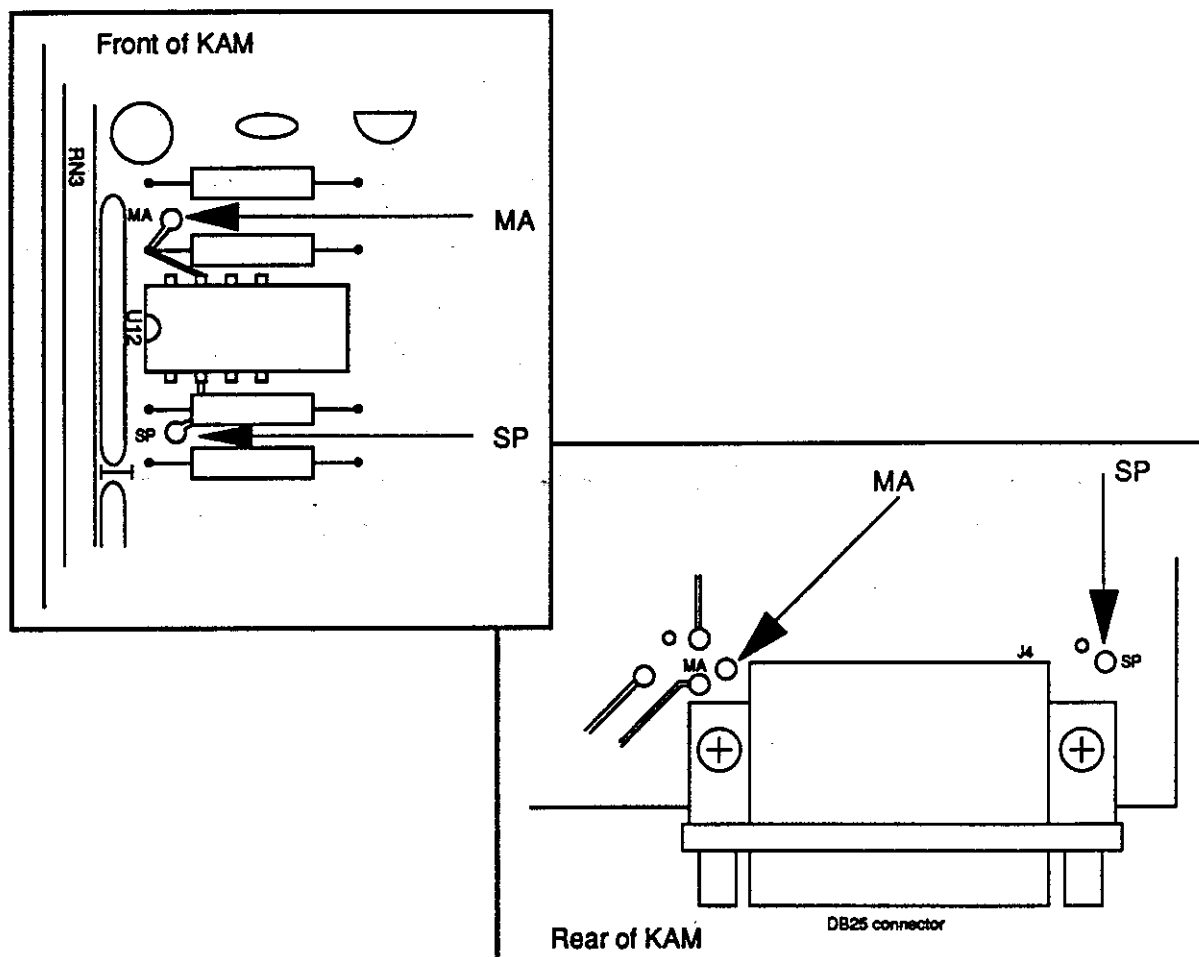

Dumb Modem Mode

KPC-1, KPC-2 and KPC-2400 Only

The TNC can also be used as a straight-through or dumb modem. In this mode the TNC does not use any of the protocols or special characteristics of packet radio. Instead, the TNC simply outputs any information sent through the RS-232/TTL port, at up to 1200 baud.

To utilize the dumb modem feature, you must PERM the MODEMENA parameter ON. Hold the RTS line of the RS-232 connector at a negative voltage when the TNC is powered on. If the connector is set to the TTL level position, the RTS line must be held at a positive 5 volts when the TNC is powered on.

To operate in the dumb modem mode you must utilize the RTS and CTS lines. The TNC will function as a true RS-232 device, using these lines to control transmit and receive operation. The transmit and receive LED on the front panel will be operational. This mode uses the PERMed parameters as specified by the HF, HFT and CCITT command and checks the status of the EQUALIZE parameter.

To exit this mode you must turn the TNC off and power up with RTS free.

Performing a Loop-Back Test

KPC-4 Only

This test is to verify that your KPC-4 is functional, and that the wiring to your computer is correct.

1. Remove the KPC-4 from its case. (See the Assembly and Disassembly section.)
2. Install jumpers between the radio ports as shown.

Female DB-9 Connectors (Looking at Holes)

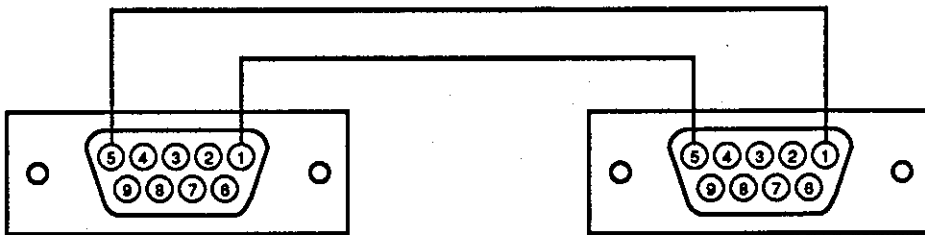

3. Remove the header connectors from AFSK level jumpers K3 and K4.
4. Set a different callsign for Port 2. For example:
MYCALL WK5M/WK5M-9
5. At the CMD: prompt enter a connect request to the callsign you have set for Port 2. Your display should look like this:
CMD: C WK5M-9 (<CR>)
When you enter the carriage return the following will appear on your display:
CMD: ~A*** CONNECTED TO WK5M
!A*** CONNECTED TO WK5M-9
You are now in Convers Mode, connected to your Port 2. Type: HELLO <CR> and the following will be added to your display:
HELLO (you typed this for transmission on Port 1)
!AHELLO (this was received by Port 2)
6. You can manipulate transmission/reception between radio Port 1 and radio Port 2 by using the proper STREAMSW command, the ~ or !, or whatever streamswitch characters you have chosen.
7. These steps have shown that your KPC-4 is functional and that wiring to your computer is correct.

Modem Disconnect

KAM and KPC-4 only

Headers are appropriately labeled on the PC board. Refer to the parts location diagram for help in locating them. Also refer to the Assembly and Disassembly section for information on obtaining access to the interior of the TNC.

Headers K8 and K9

These connectors are provided for use with an external modem such as the KM-2400 modem (QPSK) or the MSK modem.

SWDETLED Modification

KPC-1 Only

To perform the Software Carrier Detect LED enable modification, (SWDETLED) remove the circuit board from the case as detailed in the Assembly and Disassembly section. Next, remove the 7910 IC (U-11) and bend pin 25 out slightly so that it will not make contact with the socket when the IC is re-inserted in U-11. Re-install the 7910 in socket U-11. With this modification completed, you will not detect ANY packets unless CD is set to SOFTWARE.

This page left blank intentionally

40 SWDETLED MODIFICATION

Version 2.85
Installation Manual

© Copyright 1989, Kantronics, Inc. All Rights Reserved.
Duplication of this manual or the firmware without
permission of Kantronics, Inc. is prohibited.

Sample Terminal Programs

The following BASIC programs can be used to operate the Kantronics TNCs with the computers listed.

CAUTION: Each of the programs is a simple example of the necessary statements required to configure the computer for operation with an external device via the RS-232/TTL port. These simple terminal programs will NOT do file transfers or buffering of data and typing.

BASIC terminal program for the VIC-20/C-64

```
10 CLOSE2
20 OPEN2,2,3,CHR$(6)
30 GET#2,A$
40 REM
50 GET B$
55 IF B$=CHR$(133) THEN GOTO 100
60 IF B$<>"" THEN PRINT#2,B$;
70 GET#2,C$
80 PRINT C$;
90 GOTO 50
100 CLOSE2
110 END
```

The #1 function key will return the C-64 computer to BASIC. If graphics characters appear, use the shift key with the Commodore key to change the character set. For use with the VIC-20, change the TNC COMMAND parameter to \$05 (see Commands section of Commands Manual). Then a Ctrl-2 typed on the VIC-20 will return the TNC to the Command Mode. (The VIC-20 does not have a Ctrl-C command.)

This program uses a 3-wire cable as described in the Connecting Your Computer section. Wire only RXD, TXD and SG.

BASIC terminal program for the TRS-80 Model III

```
1 OUT 232,0
2 OUT232,164
3 OUT233,85
4 CLS
10 IF INP(234) and 128 then print CHR$(INP(235));GOTO 10
20 A$=INKEY$:IF A$="" THEN 10
30 IF INP(234)and 64 THEN OUT 235,ASC(A$): GOTO 10 ELSE GOTO 30
```

Put the TRS-80 Model III in BASIC. Type and run the program. When the program is run the screen will go blank. At this time turn on the TNC. The TNC will send the PRESS * FOR AUTOBAUD routine.

This program uses a 3-wire cable as described in the Connecting Your Computer section. Wire only RXD, TXD and SG.

BASIC terminal program for the Apple computer with the Super Serial Card

```
10 REM THIS PROGRAM SETS UP THE SSC FOR THE TNC
20 REM ASSUMES THE SSC IS IN SLOT #2
30 A$=CHR$(1):D$=CHR$(4)
40 PRINT D$;"PR#2"
50 PRINT A$;"6 BAUD":REM SET 300 BAUD
60 PRINT A$;"0 DATA":REM 8 DATA, 1 STOP BIT
70 PRINT A$;"0 PARITY":REM NO PARITY
75 PRINT A$;"SD":REM DISABLE SPECIAL CHARS & ENABLE ESC KEY
80 PRINT A$;"TERM MODE"
90 REM IN TERMINAL MODE-TALK TO TNC
100 REM PRESS<CTRL RESET>TO EXIT PROGRAM
110 PRINT A$;"RESET"
120 END
```

BASIC terminal program for the Zenith Z-100

```
10 KEY OFF: CLS: CLOSE
20 OPEN"COM1:300,N,8,1" AS #1:
30 OPEN"SCRN:"FOR OUTPUT AS #2:
40 A$=INKEY$:IF A$=""THEN 60
50 PRINT #1,A$
60 IF LOC(1)=0 THEN 40
70 B$=INPUT$(LOC(1),#1)
80 PRINT #2,B$
90 GOTO 40
```

BASIC terminal program for the Atari 850 Interface

```
10 GOSUB 1600
20 FOR LOOP=0 TO 1 STEP 0
50 IF PEEK(764)=255 THEN 80
60 GET #KEY,A:IF A=126 THEN A=8
70 PUT #1,A
80 STATUS #1,A:BUF=PEEK(747)
90 IF BUF=0 THEN NEXT LOOP
100 FOR I=1 TO BUF
110 GET #1,A:IF A=8 THEN A=126
120 ?CHR$(A);:NEXT I
140 NEXT LOOP
1600 KEY=4
1610 XIO 36,#1,8,0,"R1:" :REM-300 BAUD
1630 XIO 34,#1,48,0,"R1:" :REM-RTS ON
1640 OPEN #1,13,0,"R1:"
1650 XIO 40,#1,0,0,"R1:"
1655 OPEN #KEY,4,0,"K:"
1660 RETURN
```

This program uses a 5-wire cable as described in the Connecting Your Computer section. When using this program, set the TNC's DELETE and AUTOLF commands to OFF.

This page left blank intentionally

Specifications

KAM, KPC-4, KPC-2, KPC-2400, KPC-1

Size: KAM: 1-3/4" x 6" x 9"
KPC-4, KPC-2, KPC-2400, KPC-1: 1-3/4" x 6" x 8"

Weight: KAM: 2-1/2 lbs.
KPC-4, KPC-2, KPC-2400, KPC-1: 2-1/4 lbs.

Power Requirements: KAM: 11 VDC to 14 VDC < 300 ma
KPC-4: 11 VDC to 14 VDC < 200 ma
KPC-2: 9 VDC to 14 VDC < 250 ma
KPC-2400: 10 VDC to 15 VDC < 330 ma
KPC-1: 10 VDC to 14 VDC < 330 ma

Power Plug Polarity: All units: Center pin positive

Watch Dog Timer: KAM, KPC-4, KPC-2400: ≈2-1/2 minutes
(Optional board for other units)

External Carrier Detect (XCD): KAM, KPC-4: Pulldown to ground

External Reset: KPC-4: Pulldown to ground

PTT Output: All units: Open collector, +40 VDC max

FSK Output: KAM HF: Open collector, +40VDC max

Key Output: KAM HF: Reed relay contact rated 0.5A and 300 VDC max
(100Ω series resistance)

Audio Output:	KAM HF	All Others
Output Drive:	100 mvpp (LO) 500 mvpp (HI) 1.6 vpp (no jump)	10 mvpp (LO) 50 mvpp (HI) 1.7 vpp (no jump) (does not apply to KPC-1)

Output Impedance: (ac coupled)	600 Ω	600 Ω
-----------------------------------	-------	-------

Audio Input:	KAM HF	All Others
Input Sensitivity:	20 mvpp (FM) 100 mvpp (AM)	20 mvpp
Dynamic Range:	>60 dB	>60 dB
Input Impedance: (unbalanced)	600 Ω	600 Ω
Max Input Voltage:	±12 VDC	±12 VDC

Modes of Operation:
KAM: Packet, CW, RTTY, ASCII, AMTOR (CCIR 476 and CCIR 625),
WEFAX, KISS, NAVTEX/AMTEX, Host
All Others: Packet, WEFAX, KISS, Host

Other Features:
All units: PBBS, KA-NODE
KAM, KPC-4: Dual-port with gateway and cross-connect

This page left blank intentionally

KAM Parts List

C1	- .01uf	C54	- .1uf	L6	- GREEN
C2	- .01uf	C55	- .1uf	L7	- GREEN
C3	- .1uf	C56	- .01uf	L8	- RED
C4	- .001uf	C57	- .001uf	Q1	- PN2222
C5	- .001uf	C58	- .001uf	Q2	- PN2222
C6	- .001uf	C59	- .001uf	Q3	- PN2222
C7	- 1uf Alum	C60	- .001uf	Q4	- PN2222
C8	- .001uf	C61	- .001uf	Q5	- PN2907A
C9	- .001uf	C62	- .1uf	Q6	- 2N7000
C10	- .1uf	CR1	- 1N4003	Q7	- PN2907A
C11	- .001uf	CR2	- 1N4003	Q8	- PN2907A
C12	- .001uf	CR3	- 1N4003	Q9	- PN2222
C13	- .1uf	CR4	- 1N4003	Q10	- PN2907A
C14	- .1uf	CR5	- 1N914	Q11	- PN2222
C15	- 1uf Alum	CR6	- 1N914	R1	- 620
C16	- .1uf	CR7	- 1N914	R2	- 620
C17	- .001uf	CR8	- 1N914	R3	- 10K
C18	- 1 uf Alum	CR9	- 1N914	R4	- 100K
C19	- 47uf Alum	CR10	- 1N914	R5	- 620
C20	- 47uf Alum	CR11	- 1N914	R6	- 47K
C21	- .001uf	CR12	- 1N914	R7	- 10K
C22	- .1uf	CR13	- 1N914	R8	- 4.7K
C23	- .1uf	CR14	- 1N914	R9	- 6.8K
C24	- .01uf	CR15	- 1N914	R10	- 620
C25	- 20pf	CR16	- 1N914	R11	- 220
C26	- 20pf	CR17	- 1N4003	R12	- 1K
C27	- .1uf	CR18	- 1N4003	R13	- 100K
C28	- .1uf	CR19	- 1N914	R14	- 1M
C29	- 1uf Alum	CR20	- 1N914	R15	- 1M
C30	- .01uf	CR21	- 1N914	R16	- 1M
C31	- .01uf	J1	- 2.5 mm Barrel	R17	- 470
C32	- 4.7uf Alum	J2	- 9 Pin - D	R18	- 47K
C33	- 4.7uf Alum	J3	- 8 Pin Din	R19	- 2.2K
C34	- .01uf	J4	- 25 Pin - D	R20	- 10K
C35	- .01uf	K1	- 3 Pin	R21	- 1M
C36	- 330pf	K2	- 3 Pin	R22	- 10K
C37	- .01uf	K3	- 2 Pin	R23	- 10K
C38	- .1uf	K4	- 2 Pin	R24	- 1.5K
C39	- 10uf Tant	K5	- 3 Pin	R25	- 10K
C40	- .1uf	K6	- 3 Pin	R26	- 6.8K
C41	- .1uf	K7	- 3 Pin	R27	- 15K
C42	- 10uf 50V Alum	K8	- 20 Pin	R28	- 15K
C43	- 10uf 50V Alum	K9	- 6 Pin	R29	- 10K
C44	- .1uf	L1	- GREEN	R30	- 22K
C45	- .001uf	L2	- GREEN	R31	- 150K
C46	- .1uf	L3	- GREEN	R32	- 150K
C48	- .1uf	L4	- GREEN	R33	- 100K
C49	- 25pf	L5	- RED	R34	- 100K
C50	- 33pf			R35	- 2.7K
C51	- .1uf			R36	- 1.2K
C52	- .1uf				

© COPYRIGHT 1986 KANTONICS CO., INC. ALL RIGHTS RESERVED

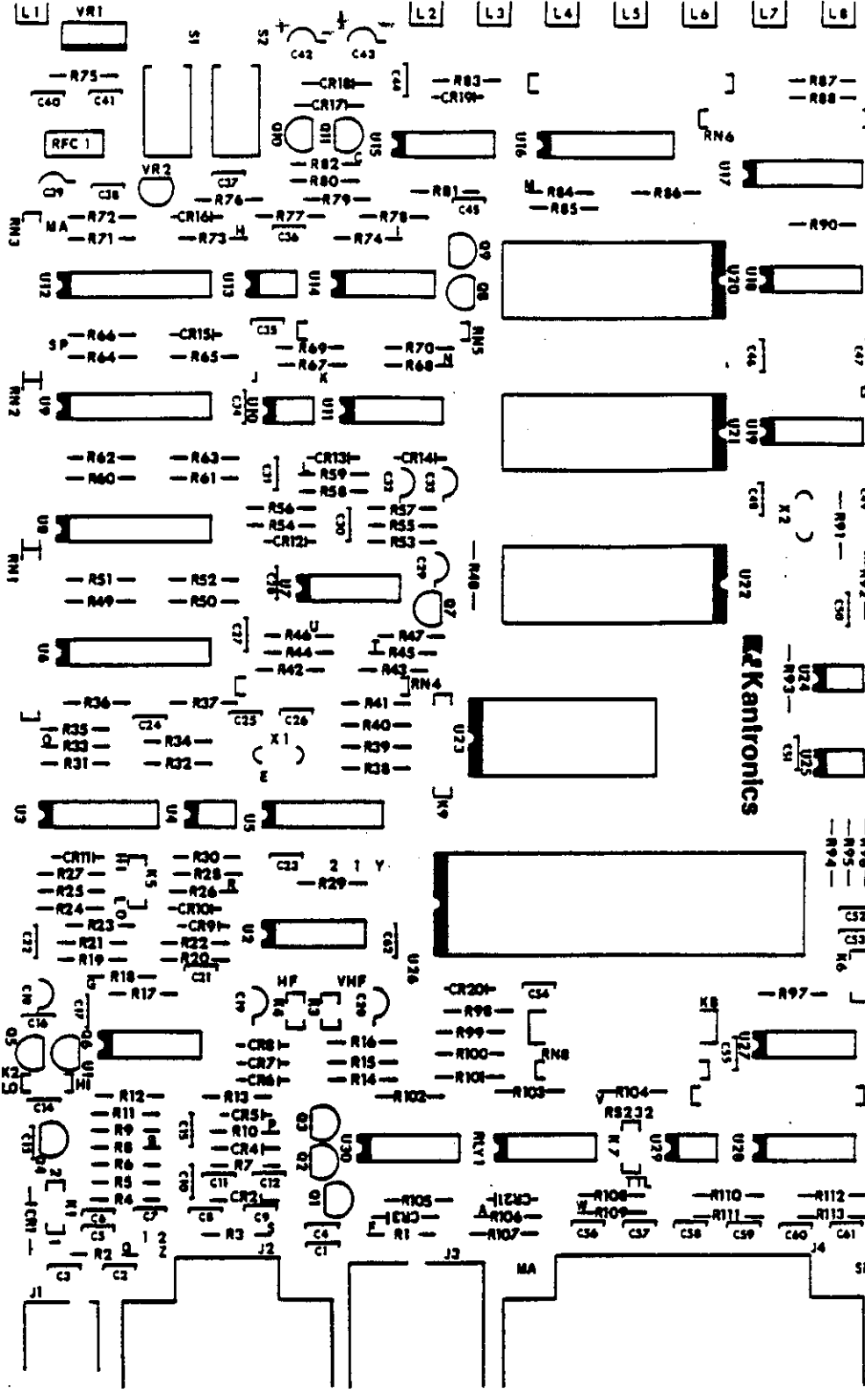

Kantronics

X 1 2
R96
R95
R94

R97
R98
R99
R100
R101
R102

R103
R104
R105
R106
R107
R108
R109
R110
R111
R112

R113
R114
R115
R116
R117
R118
R119
R120
R121
R122
R123
R124
R125
R126
R127
R128
R129
R130

R131
R132
R133
R134
R135
R136
R137
R138
R139
R140
R141
R142
R143
R144
R145
R146
R147
R148
R149
R150
R151
R152
R153
R154
R155
R156
R157
R158
R159
R160
R161
R162
R163
R164
R165
R166
R167
R168
R169
R170
R171
R172
R173
R174
R175
R176
R177
R178
R179
R180
R181
R182
R183
R184
R185
R186
R187
R188
R189
R190
R191
R192
R193
R194
R195
R196
R197
R198
R199
R200
R201
R202
R203
R204
R205
R206
R207
R208
R209
R210
R211
R212
R213
R214
R215
R216
R217
R218
R219
R220
R221
R222
R223
R224
R225
R226
R227
R228
R229
R230
R231
R232
R233
R234
R235
R236
R237
R238
R239
R240
R241
R242
R243
R244
R245
R246
R247
R248
R249
R250
R251
R252
R253
R254
R255
R256
R257
R258
R259
R260
R261
R262
R263
R264
R265
R266
R267
R268
R269
R270
R271
R272
R273
R274
R275
R276
R277
R278
R279
R280
R281
R282
R283
R284
R285
R286
R287
R288
R289
R290
R291
R292
R293
R294
R295
R296
R297
R298
R299
R300
R301
R302
R303
R304
R305
R306
R307
R308
R309
R310
R311
R312
R313
R314
R315
R316
R317
R318
R319
R320
R321
R322
R323
R324
R325
R326
R327
R328
R329
R330
R331
R332
R333
R334
R335
R336
R337
R338
R339
R340
R341
R342
R343
R344
R345
R346
R347
R348
R349
R350
R351
R352
R353
R354
R355
R356
R357
R358
R359
R360
R361
R362
R363
R364
R365
R366
R367
R368
R369
R370
R371
R372
R373
R374
R375
R376
R377
R378
R379
R380
R381
R382
R383
R384
R385
R386
R387
R388
R389
R390
R391
R392
R393
R394
R395
R396
R397
R398
R399
R400
R401
R402
R403
R404
R405
R406
R407
R408
R409
R410
R411
R412
R413
R414
R415
R416
R417
R418
R419
R420
R421
R422
R423
R424
R425
R426
R427
R428
R429
R430
R431
R432
R433
R434
R435
R436
R437
R438
R439
R440
R441
R442
R443
R444
R445
R446
R447
R448
R449
R450
R451
R452
R453
R454
R455
R456
R457
R458
R459
R460
R461
R462
R463
R464
R465
R466
R467
R468
R469
R470
R471
R472
R473
R474
R475
R476
R477
R478
R479
R480
R481
R482
R483
R484
R485
R486
R487
R488
R489
R490
R491
R492
R493
R494
R495
R496
R497
R498
R499
R500
R501
R502
R503
R504
R505
R506
R507
R508
R509
R510
R511
R512
R513
R514
R515
R516
R517
R518
R519
R520
R521
R522
R523
R524
R525
R526
R527
R528
R529
R530
R531
R532
R533
R534
R535
R536
R537
R538
R539
R540
R541
R542
R543
R544
R545
R546
R547
R548
R549
R550
R551
R552
R553
R554
R555
R556
R557
R558
R559
R560
R561
R562
R563
R564
R565
R566
R567
R568
R569
R570
R571
R572
R573
R574
R575
R576
R577
R578
R579
R580
R581
R582
R583
R584
R585
R586
R587
R588
R589
R590
R591
R592
R593
R594
R595
R596
R597
R598
R599
R600
R601
R602
R603
R604
R605
R606
R607
R608
R609
R610
R611
R612
R613
R614
R615
R616
R617
R618
R619
R620
R621
R622
R623
R624
R625
R626
R627
R628
R629
R630
R631
R632
R633
R634
R635
R636
R637
R638
R639
R640
R641
R642
R643
R644
R645
R646
R647
R648
R649
R650
R651
R652
R653
R654
R655
R656
R657
R658
R659
R660
R661
R662
R663
R664
R665
R666
R667
R668
R669
R670
R671
R672
R673
R674
R675
R676
R677
R678
R679
R680
R681
R682
R683
R684
R685
R686
R687
R688
R689
R690
R691
R692
R693
R694
R695
R696
R697
R698
R699
R700
R701
R702
R703
R704
R705
R706
R707
R708
R709
R710
R711
R712
R713
R714
R715
R716
R717
R718
R719
R720
R721
R722
R723
R724
R725
R726
R727
R728
R729
R730
R731
R732
R733
R734
R735
R736
R737
R738
R739
R740
R741
R742
R743
R744
R745
R746
R747
R748
R749
R750
R751
R752
R753
R754
R755
R756
R757
R758
R759
R760
R761
R762
R763
R764
R765
R766
R767
R768
R769
R770
R771
R772
R773
R774
R775
R776
R777
R778
R779
R780
R781
R782
R783
R784
R785
R786
R787
R788
R789
R790
R791
R792
R793
R794
R795
R796
R797
R798
R799
R800
R801
R802
R803
R804
R805
R806
R807
R808
R809
R810
R811
R812
R813
R814
R815
R816
R817
R818
R819
R820
R821
R822
R823
R824
R825
R826
R827
R828
R829
R830
R831
R832
R833
R834
R835
R836
R837
R838
R839
R840
R841
R842
R843
R844
R845
R846
R847
R848
R849
R850
R851
R852
R853
R854
R855
R856
R857
R858
R859
R860
R861
R862
R863
R864
R865
R866
R867
R868
R869
R870
R871
R872
R873
R874
R875
R876
R877
R878
R879
R880
R881
R882
R883
R884
R885
R886
R887
R888
R889
R890
R891
R892
R893
R894
R895
R896
R897
R898
R899
R900
R901
R902
R903
R904
R905
R906
R907
R908
R909
R910
R911
R912
R913
R914
R915
R916
R917
R918
R919
R920
R921
R922
R923
R924
R925
R926
R927
R928
R929
R930
R931
R932
R933
R934
R935
R936
R937
R938
R939
R940
R941
R942
R943
R944
R945
R946
R947
R948
R949
R950
R951
R952
R953
R954
R955
R956
R957
R958
R959
R960
R961
R962
R963
R964
R965
R966
R967
R968
R969
R970
R971
R972
R973
R974
R975
R976
R977
R978
R979
R980
R981
R982
R983
R984
R985
R986
R987
R988
R989
R990
R991
R992
R993
R994
R995
R996
R997
R998
R999
R1000

KAM CPU/VHF MODEM

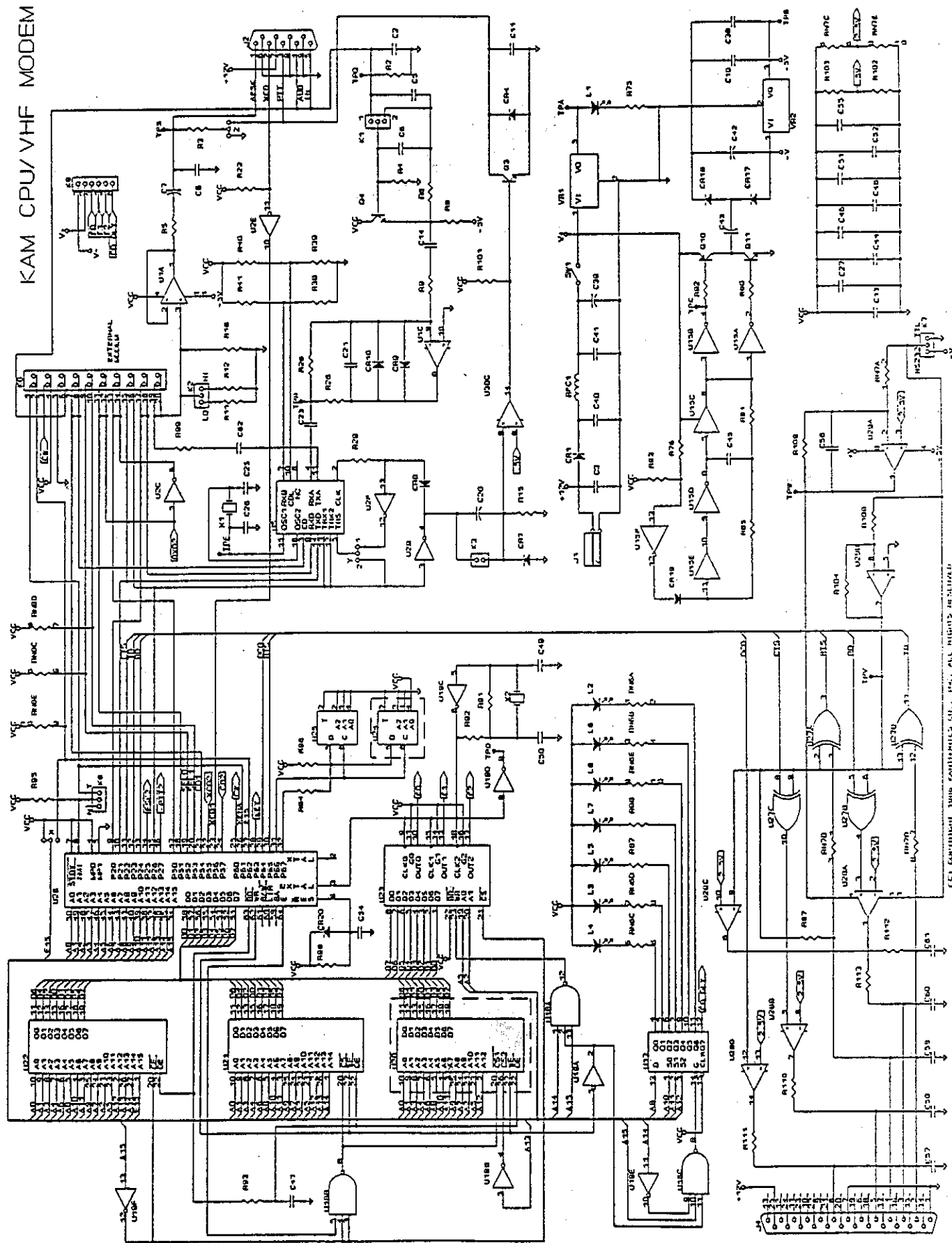

(C) EQUIPMENT BOMB CORPORATION, CHICAGO, ILL. ALL RIGHTS RESERVED.

KAM HF MODEM

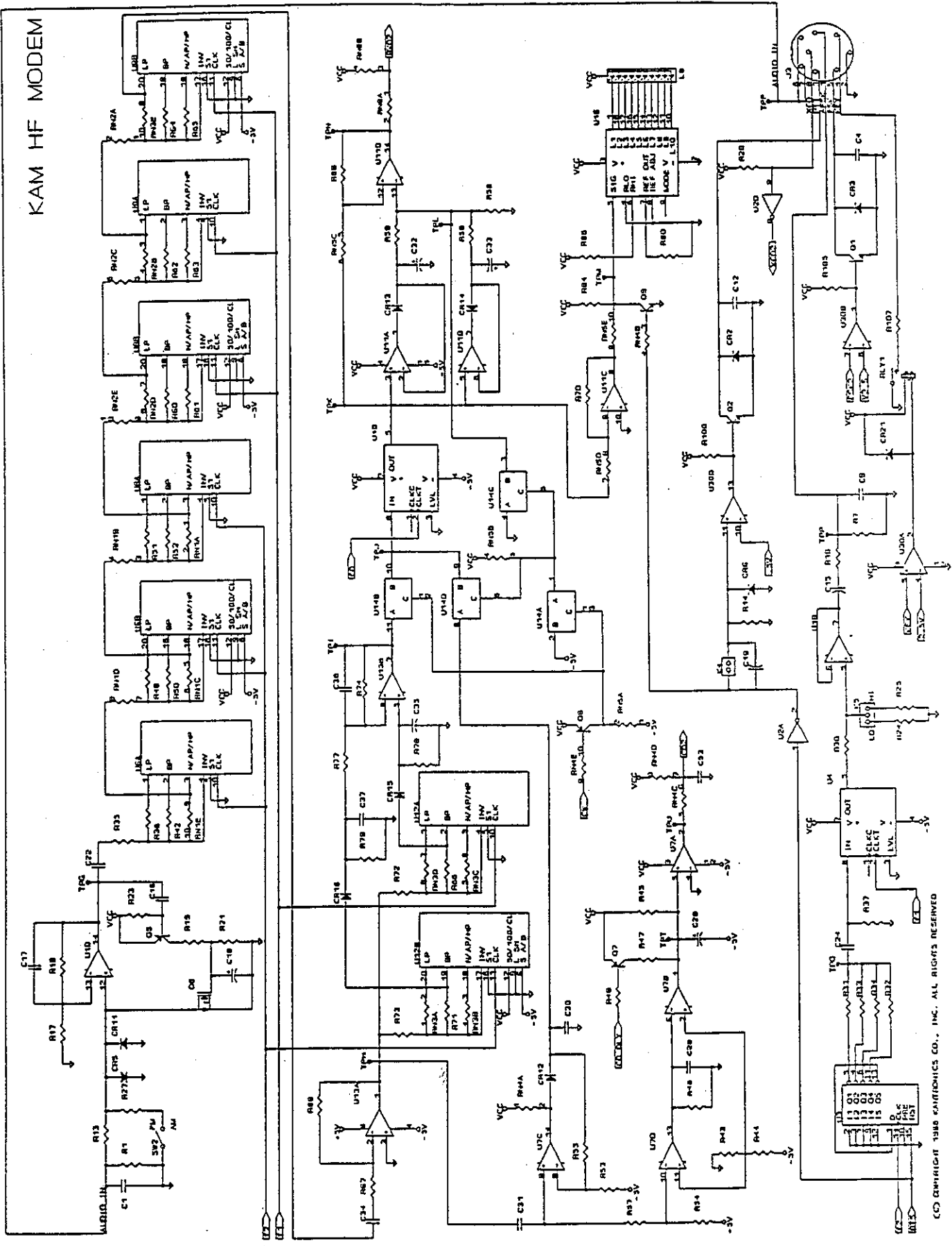

KPC-4 Parts List

C1 - .1	C54 - .001	R27 - 220
C2 - 20pf	C55 - .001	R28 - 1M
C3 - 20pf	C56 - .001	R29 - 1K
C4 - .001	C57 - .1	R30 - 33K
C5 - .001		R31 - 33K
C6 - .001	CR1 - 1N914	R32 - 8.45 K
C7 - .01	CR2 - 1N914	R33 - 10K
C8 - .001	CR3 - 1N914	R34 - 2.2K
C9 - .01	CR4 - 1N914	
C10 - .1	CR5 - 1N914	R39 - 9.1K
C11 - .001	CR6 - 1N914	R40 - 33K
C12 - .001	CR7 - 1N914	R41 - 2.2K
C13 - 1uf	CR8 - 1N4001	R42 - 1M
C14 - 1uf	CR9 - 1N4001	R43 - 1M
C15 - .001	CR10 - 1N4001	R44 - 1M
C16 - .001	CR11 - 1N4001	R45 - 10K
C17 - .1	CR12 - 1N4001	R46 - 100K
C18 - .1	CR13 - 1N914	R47 - 1K
C19 - .1		R48 - 1K
C20 - .001	Q1 - PN2222	R49 - 100K
C21 - .001	Q2 - PN2222	R50 - 10K
C22 - .1	Q3 - PN2222	R51 - 220
C23 - .1	Q4 - PN2222	R52 - 2.2K
C24 - .1	Q5 - PN2907	R53 - 2.2K
C25 - .1	Q6 - 2N2222	R54 - 100K
		R55 - 22K
C28 - 47uf	R1 - 100K	R56 - 220
C29 - 47uf	R2 - 100K	R57 - 220
C30 - .1uf	R3 - 10K	R58 - 220
C31 - 20pf	R4 - 620	R59 - 100K
C32 - 20pf	R5 - 620	R60 - 2.2K
C33 - .1	R6 - 100K	R61 - 100K
C34 - .1	R7 - 10K	R62 - 10K
C35 - 10uf Tant	R8 - 10K	R63 - 6.8K
C36 - .1	R9 - 100K	R64 - 51K
C37 - .1	R10 - 47K	R65 - 100K
C38 - 4.1	R11 - 4.7K	R66 - 120K
C39 - .1	R12 - 4.7K	R67 - 6.8K
C40 - 10	R13 - 47K	R68 - 270
C41 - 10	R14 - 620	R69 - 270
C42 - .1	R15 - 10K	R70 - 6.8K
C43 - .001	R16 - 10K	R71 - 270
C44 - .1	R17 - 620	
C45 - .1	R18 - 15K	RFC1 - 10uh
C46 - .1	R19 - 6.8K	
C47 - .1	R20 - 6.8K	S1P1 - 220
C48 - .1	R21 - 15K	S1P2 - 100K
C49 - .1	R22 - 6.8K	S1P3 - 10K
C50 - .01	R23 - 1K	
C51 - .001	R24 - 1M	U1 - MC34074
C52 - .001	R25 - 220	U2 - 3105
C53 - .001	R26 - 6.8K	U3 - 3105

KPC-4 COMPONENT PLACEMENT DIAGRAM

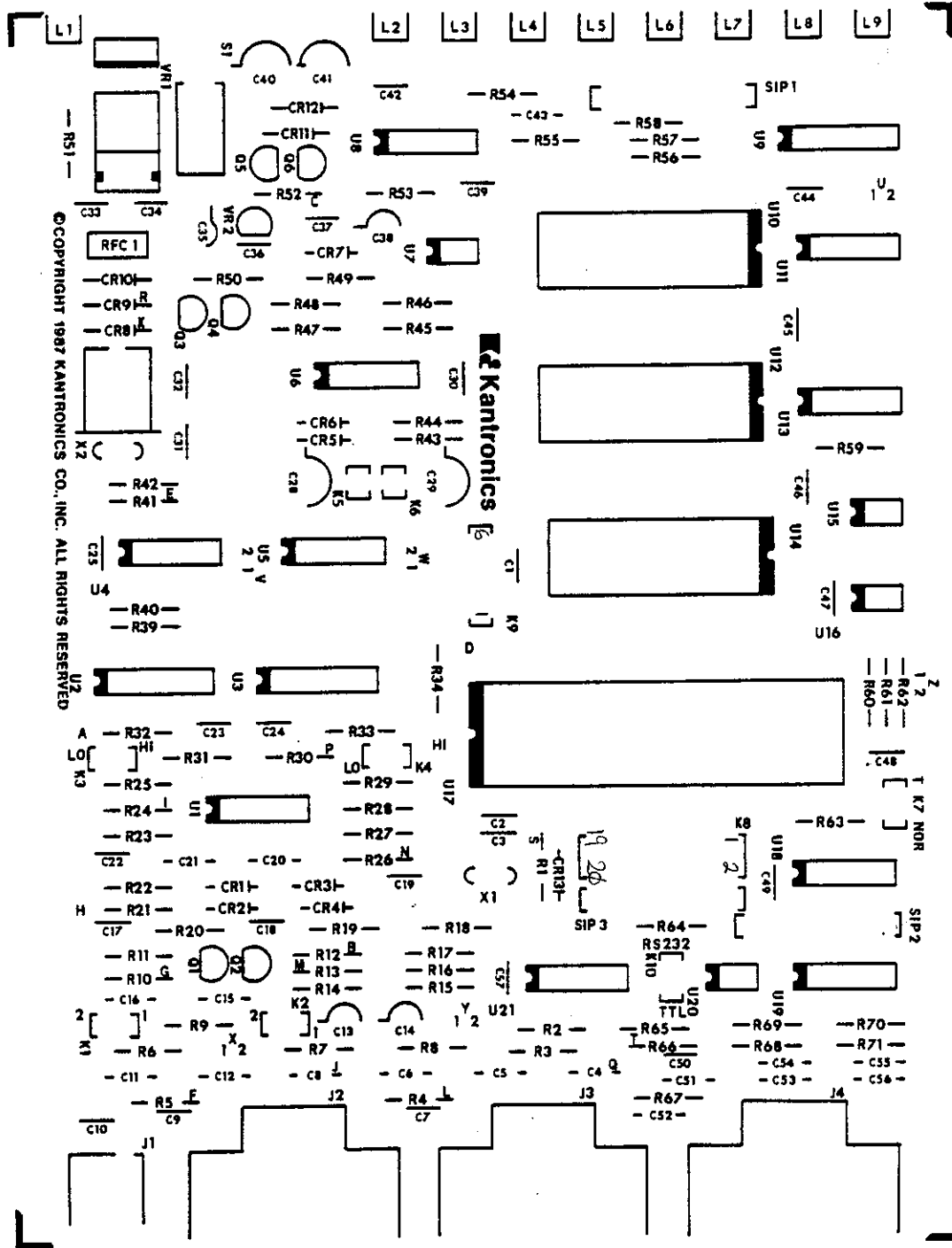

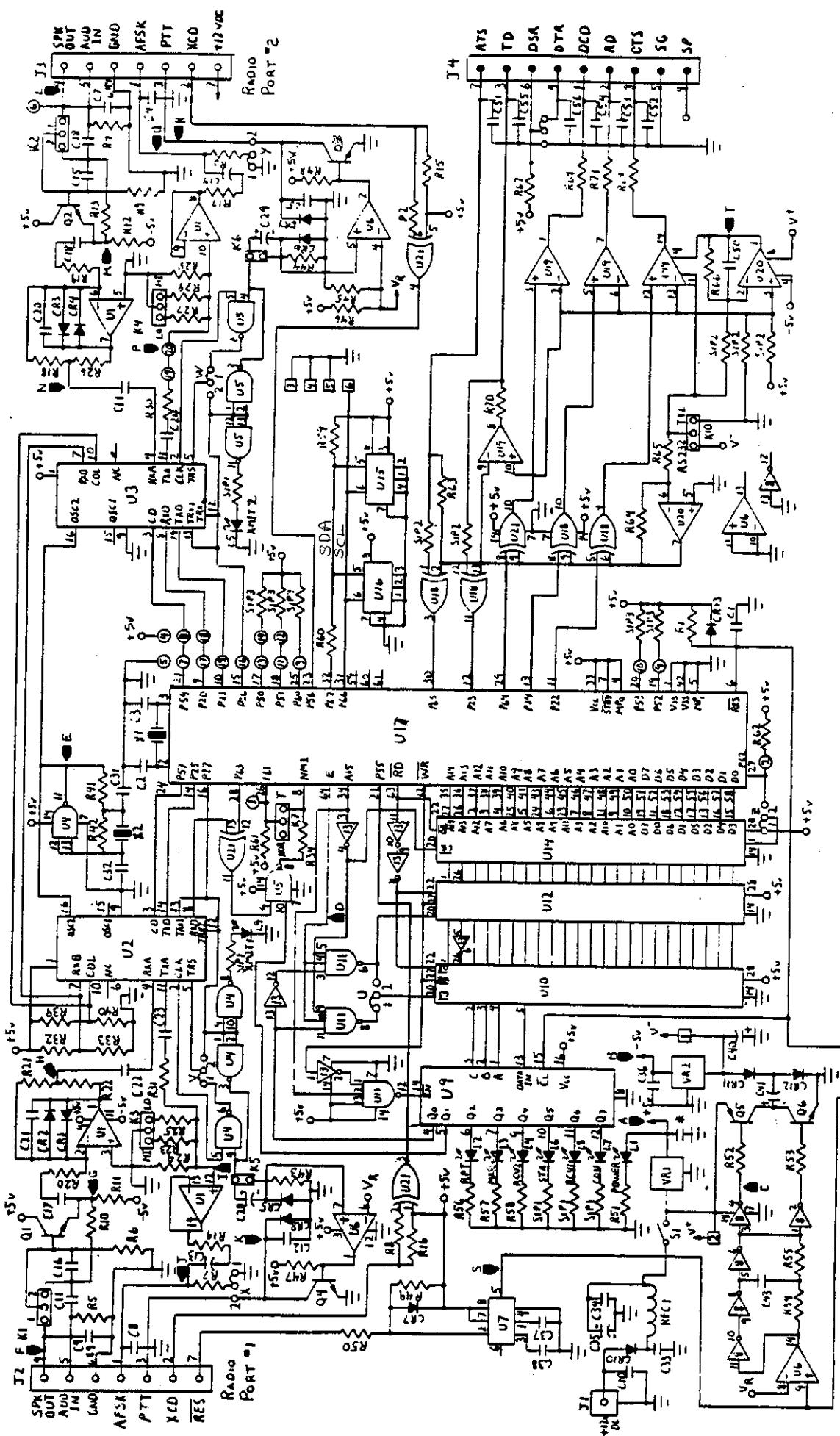

* +5v Bypass C25, C30, C39, C42, C44, C45, C46, C47, C48, C49

▲ TEST POINT

○ KB PINS

□ K9 PINS

KPC-4

KPC-2 Parts List

C1 - 10uf Tant	J1 - power jack	R25 - 6.8K
C2 - .001 Disc	J2 - 9 pin D-connector	R26 - 6.8K
C3 - 4.7 uf Alum	J3 - 3.5 audio jack	R27 - 120K
C4 - 4.7 uf Alum	J4 - 25 pin D-connector	R29 - 100K
C5 - .1 MLC		R30 - 51K
C6 - .1 MLC	K-1 3 pin header	R31 - 120K
C7 - .1 MLC	K-2 3 pin header	R32 - 10K
C8 - .1 MLC	K-3 3 pin header	R33 - 100K
C9 - .1 MLC		R34 - 10K
C10 - .002 Disc	L-1 Red LED	R35 - 100K
C11 - 20 pf	L-2 Red LED	R36 - 10K
C13 - .1 MLC	L-3 Red LED	R37 - 2.2K
C14 - .1 MLC	L-4 Red LED	R38 - 100K
C15 - .01 Disc	L-5 Green LED	R39 - 4.7K
C16 - .01 Disc		R40 - 220
C17 - .001 MLC	N1 J5	R41 - 220
C18 - .01 Disc	Q1 M1 jumper	R42 - 220
C19 - .1 ML	hole 9-10	R43 - 220
C20 - .01 Disc		R44 - 220
C21 - .001 Disc	Q1 - PN2907A	RFC1- 10uh
C22 - .001 Disc	Q2 - PN2222	S1 - push push switch
C23 - 1 uf Alum	Q3 - PN2222	
C24 - .01 Disc		S1P1 - 10K
C25 - .001 Disc	R1 - 100K	S1P2 - 100K
C26 - .001 Disc	R2 - 120K	
C27 - .001 Disc	R3 - 100K	U1 - 7910 28 pin socket
C28 - .001 Disc	R4 - 4.7K	U2 - LM358
C29 - .001 Disc	R5 - 22K	U3 - LM358
C30 - .001 Disc	R6 - 4.7K	U4 - MC34074
C31 - 20 pf	R7 - 1M	U5 - 74HC14
C32 - 20 pf	R8 - 100	U6 - 4070
C34 - .1 MLC	R9 - 100K	U7 - 4070
C35 - .1 MLC	R10 - 33K	U8 - 63B03X 64 pin socket
C36 - .1 MLC	R11 - 100K	U9 - 27256 28 pin socket
C37 - .1 MLC	R12 - 100 ohm	U11 - 62256 25 pin socket
C38 - .1 MLC	R13 - 1M	U12 - 2404 8 pin socket
C39 - .1 MLC	R14 - 470	U14 - 74HC04
	R15 - 100K	U15 - 4069
CR1 - 1N914	R16 - 3.3K	
CR2 - 1N4003	R17 - 4.7K	VR1 - 78M05
CR3 - 1N4003	R18 - 620	VR2 - 79L05
CR4 - 1N4003	R19 - 620	
CR5 - 1N914	R20 - 10K	
CR6 - 1N914	R21 - 270	XTAL 1 - 2.4576 MHz
CR7 - 1N914	R22 - 270	XTAL 2 - 7.3728 MHz
CR8 - 1N914	R23 - 270	
CR9 - 1N4003	R24 - 6.8K	
CR10- 1N914		

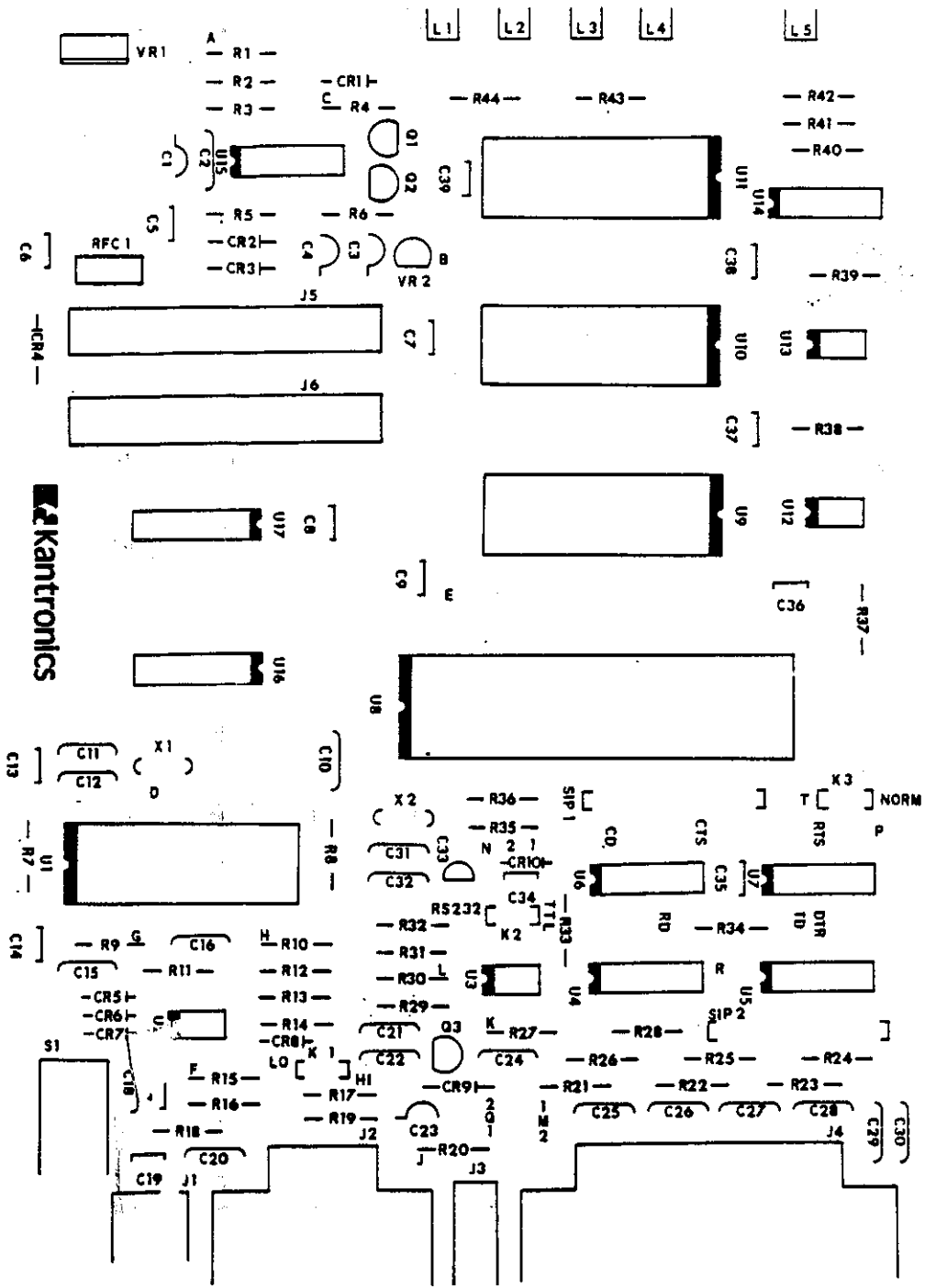

Kantronics

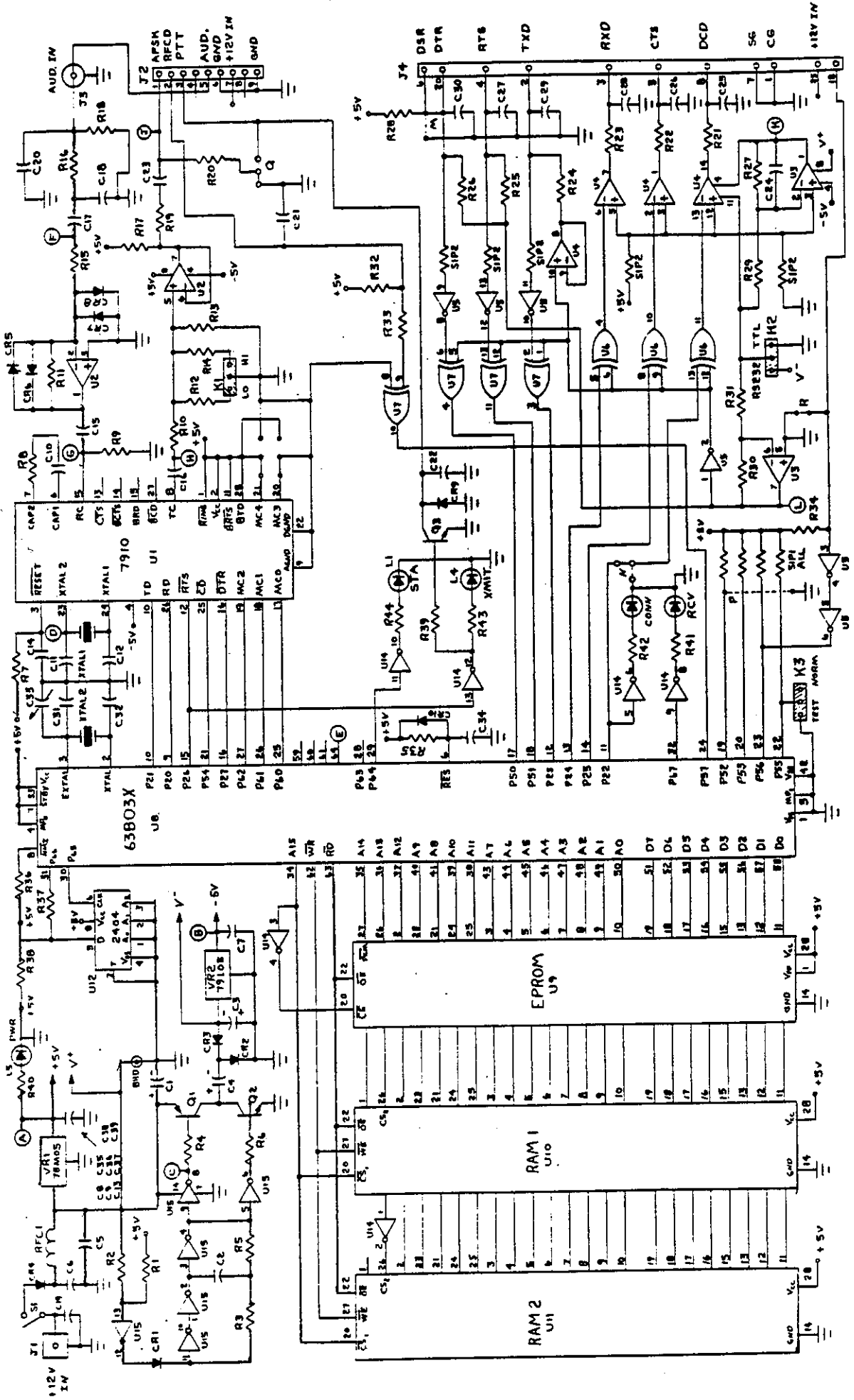

KPC-2

KPC-2400 Parts List

R1 - 620ohm	R52 - 68K	C4 - .001
R2 - 22K	R53 - 18K	C5 - .001
R3 - 100K	R54 - 33K	C6 - .001
R4 - 8.2K	R55 - 18K	C7 - .1
R5 - 4.7K	R56 - 9.53K MF	C9 - 1uf Alum
R6 - 47K	R57 - 68K	C10 - .1
R7 - 4.7K	R58 - 180K	C11 - .1
R8 - 33K	R59 - 4.7K	C12 - .001
R9 - 10K	R60 - 4.7K	C13 - .1
R10 - 18K	R61 - 100K	C14 - .01
R11 - 470K	R62 - 100K	C15 - .1
R12 - 470ohm	R63 - 22K	C16 - .002
R13 - 47K	R64 - 220ohm	C17 - 20pf
R14 - 470K	R65 - 220ohm	C19 - 33pf
R15 - 10K	R66 - 220ohm	C20 - 33pf
R16 - 4.7K	R67 - 220ohm	C21 - .1
R17 - 100K	R68 - 220ohm	C22 - .1
R18 - 1Meg	R69 - 4.7K	C23 - .01 Disc
R19 - 910ohm	R70 - 100K	C24 - .01 Disc
R20 - 2.2K	R71 - 2.2K	C25 - .1
R21 - 1Meg	R72 - 10K	C26 - 10uf
R22 - 100K	R73 - 100K	C27 - .1
R23 - 100K	R74 - 100K	C28 - 10uf Alum
R24 - 100K	R75 - 120K	C29 - 10uf Alum
R25 - 1Meg	R76 - 68K	C30 - .1
R26 - 47K	R77 - 100K	C31 - .001
R27 - 470ohm	R78 - 10K	C32 - .1
R28 - 33K	R79 - 620ohm	C33 - .1
R29 - 47K	R80 - 120K	C34 - .1
R30 - 220ohm	R81 - 6.8K	C35 - 20pf
R31 - 47K	R82 - 6.8K	C36 - 20pf
R32 - 1K	R83 - 6.8K	C37 - .1
R33 - 10K	R84 - 270ohm	C38 - .1
R34 - 100ohm	R85 - 270ohm	C39 - .1
R35 - 1Meg	R86 - 270ohm	C40 - .01 Disc
R36 - 1Meg	R87 - 10K	C41 - 1uf Alum
R37 - 2.2K	R88 - 100K	C42 - .001
R38 - 150K	RFC1 - 10uh	C43 - .001
R39 - 2.2K	XTAL 1 - 7.3728 MHz	C44 - .001
R40 - 4.7K	XTAL 2 - 2.4576 MHz	C45 - .001
R41 - 10K	XTAL 3 - 4.608 MHz	C46 - .001
R42 - 33K	S1P 1 - 100K	C47 - .001
R43 - 100K	S1P 2 - 100K	C48 - .001
R44 - 15K	S1P 3 - 100K	C49 - .001
R45 - 9.09K MF	C1 - .1	CR1 - 1N4001
R46 - 15K	C2 - .01	CR2 - 1N914
R47 - 9.09K MF	C3 - .001	CR3 - 1N914
R48 - 33K		CR4 - 1N914
R49 - 100K		
R50 - 15K		
R51 - 9.53K MF		

KPC-2400 PARTS LIST

© COPYRIGHT 1986 KANTRONICS CO., INC. ALL RIGHTS RESERVED

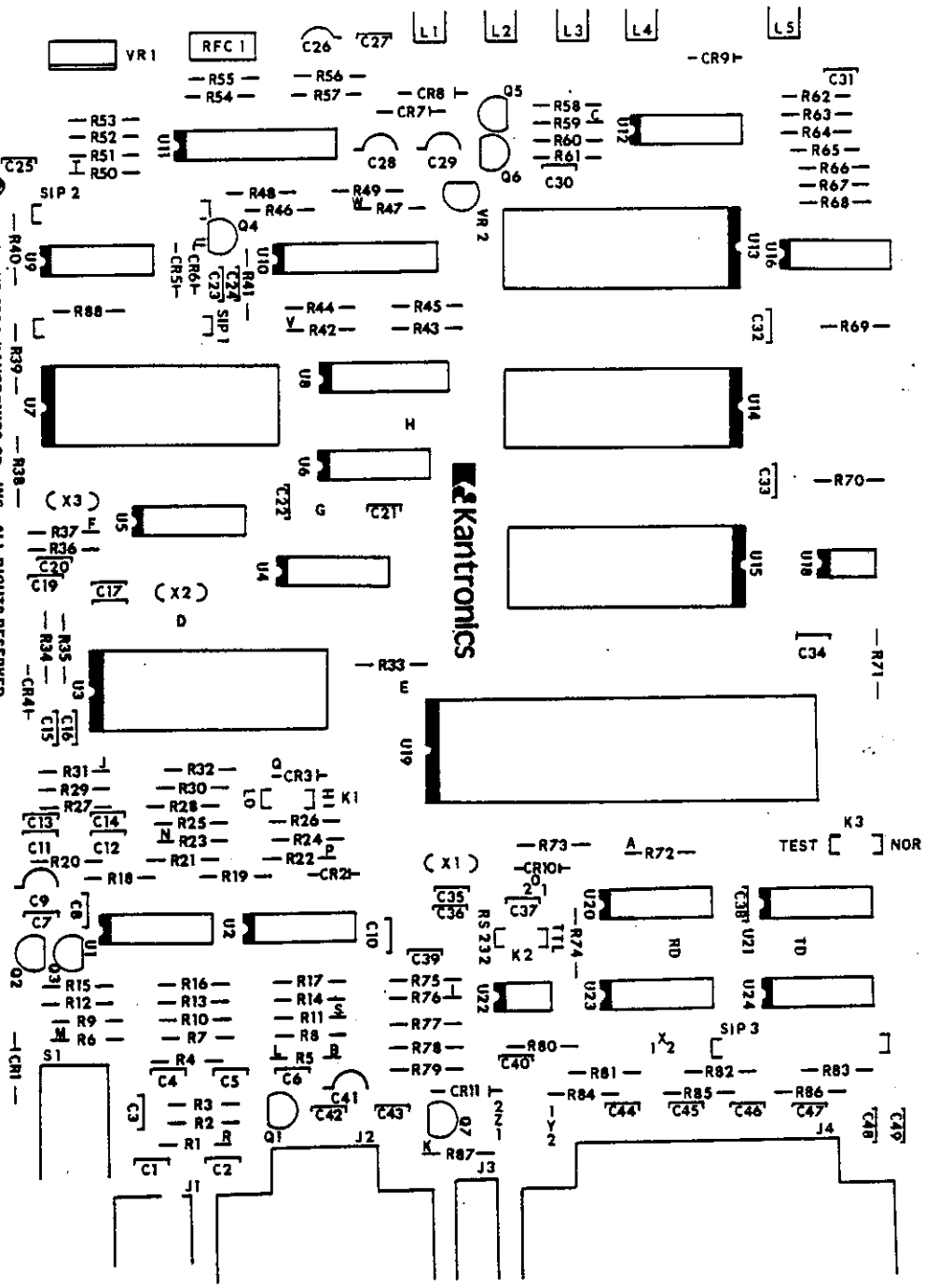

Index

C: means found in Commands Manual
O: means found in Operations Manual
I: means found in Installation Manual
CAPITAL entry signifies a TNC
command or directive

<C>, C:26
<D>, C:26
<DM>, C:26
<FRMR>, C:29
<I#>, C:26
<REJ>, C:29, O:17
<rej>, C:29, O:17
<RNR>, C:29
<<RNR>>, C:29
<rn>, C:29
<<rn>>, C:29
<RR>, C:29, O:17
<<RR>>, C:29, O:17
<rr>, C:29, O:17
<<rr>>, C:29, O:17
<UA>, C:26
<UI>, C:26
5-pin din, I:18
8-pin din, I:17
8BITCONV, C:5, O:4
a simple connect, O:12
ABAUD, C:5, O:4
ABORT, C:51, O:27, O:29
abbreviations, C:1, O:1
afsk output levels, I:19-21
ALIAS, C:5, O:13
allocate memory
 ka-node (numnodes), C:34, O:25
 maxusers, C:25, O:6
 pbbs, C:36, O:21
 navsta (navtex), C:32
amtex mode, O:50A-50B
AMTOR, C:5, O:48
 directives, O:50
 start-up mode, O:6
amtor mode, O:47-49
 changeover, O:49
 seizing link, O:49

apple super serial card sample
 program, I:42
arq mode, O:47-49
ASCBAUD, C:6, O:40, O:42
ASCII, C:6
 directives, O:45
 start-up mode, O:6
ascii chart, C:61
ascii mode, O:39-45
ascii standard, O:4
assembly/disassembly tnc, I:29
asynchronous commands, O:4
atari 850, I:13
 sample program, I:43
autobaud routine, O:3
AUTOOCR, C:6, O:42
AUTOLF, C:6, O:42
AUTOSTRT, C:6, O:42, O:48
AX25L2V2, C:7, O:16, O:17
AXDELAY, C:7
AXHANG, C:7
baudot, O:39
back panels, I:5
bargraph, O:8
 amtor, O:50
 cw, O:51
 rtty/ascii, O:41
basic programs
 apple SSC, I:42
 atari, I:43
 commodore, I:41
 trs-80 model III, I:42
 zenith z-100, I:43
baud rate, O:4, I:7
bbs (pbbs), C:16, C:51-52, O:21-23
 renumber msgs, C:36
 status, O:7-10
bbs programs, O:6, I:8
BEACON, C:8
BKONDEL, C:8
BTEXT, C:8
BUDCALLS, C:8, O:15
BUDLIST, C:9, O:15
BYE, C:51, O:29
cable wiring, I:8

CALIBRAT, C:9, I:31
 calibration/equalization, I:31-32
 calling cq
 amtor, O:49
 packet, O:12
 rtty/ascii, O:39
 CANLINE, C:9
 CANPAC, C:9
 carrier detect, C:10A, I:15, I:17
 CCITT, C:10, O:42
 CD, C:10A
 change streams, C:43
 changeover (amtor), O:49
 CHECK, C:10A
 checksum, O:11
 clear to send (cts), O:5, O:19, I:8, I:10
 clock, C:15
 cmd:, C:55, O:3
 CMDTIME, C:11, O:20
 CMSG, C:11
 COMMAND, C:11, O:11
 command mode, O:11
 commands
 alphabetically, C:5-48
 asynchronous, O:4
 dual-port set-up, O:5
 entry, C:1
 format, C:2
 types, C:2-3
 commands structure, C:1-2
 commodore, I:11
 sample program, I:41
 communications program
 host, O:30A-30B
 parameters, O:4, I:7
 split-screen, O:5
 sample programs, I:41-43
 wefax, O:31, O:33-34
 computer connections, I:7-13
 configuring your pbbs, O:21
 configuring your ka-node, O:25
 CONLIST, C:11
 CONMODE, C:12, O:13
 CONNECT (as a command), C:12, O:12
 CONNECT (as a directive), C:51, O:26,
 O:29
 connect vs. unproto, O:11
 connections
 scope, I:35
 tnc to computer, I:7-13
 tnc to radios, I:15
 connectors
 5-pin din, I:18
 8-pin din, I:17
 db-25, I:9
 db-9, I:15, I:9
 CONOK, C:12
 CONVERS, C:13
 converse mode
 calling cq, O:12
 vs. transparent mode, C:19
 CPACTIME, C:13
 cq
 amtor, O:49
 packet, O:12
 rtty/ascii, O:39
 CR, C:13
 CRADD, C:13
 CRLFSUP, C:13
 cross-connect, C:53, O:28, O:30
 CSTAMP, C:13
 CTEXT, C:14
 CTRL-C, C:49, O:11
 CTRL-C E, C:49
 CTRL-C I, C:49
 CTRL-C L, C:50
 CTRL-C n, C:49
 CTRL-C R, C:50
 CTRL-C S, C:50
 CTRL-C T, C:50
 CTRL-C U, C:50
 CTRL-C X, C:50
 CTRL-L, C:50, O:39
 CTRL-N, C:50, O:39
 ctrl-q, O:5, O:18
 ctrl-s, O:5, O:18
 CTRL-W, C:50
 cts (clear to send), O:5, O:19, I:8, I:10
 CW, C:14
 directives, O:54
 start-up mode, O:6
 cw mode, O:51-54
 CWBAND, C:14, O:51
 CWID, C:14
 CWSPEED, C:14, O:51

2 INDEX

Version 3.0 Aug. 13, 1990

© Copyright 1989, 1990, Kantronics, Inc. All Rights Reserved.
 Duplication of this manual or the firmware without
 permission of Kantronics, Inc. is prohibited.

CWTONE, C:14, O:51
 data bits, O:4, I:7
 data carrier detect (dcd)
 computer, I:8, I:10
 radio, C:10A, I:15, I:17
 data communication equip. (dce), I:8
 data set ready (dsr), I:8, I:10
 data terminal equipment (dte), I:8
 data terminal ready (dtr), I:8, I:10
 DAYTIME, C:15
 DAYTWEAK, C:15 O:33
 DAYUSA, C:15
 db-9 connector, I:15, I:9
 db-25 connector, I:4, I:9
 DBLDISC, C:15
 dcd (data carrier detect)
 computer, I:8, I:10
 radio, C:10A, I:15, I:17
 dce (data communication equipment),
 I:8
 default values, I:30
 DELETE, C:15
 delete mail, C:52, O:22
 DIDDLE, C:16, O:42
 DIGIPEAT, C:16, O:13
 digipeating, O:13, I:33-34
 directives
 ctrl-c, C:49-50
 ka-node and pbbs, C:51-53
 amtor, O:50
 cw, O:54
 rtty/ascii, O:45
 disassembly/assembly tnc, I:29
 DISCONNECT, C:16, O:13
 DISPLAY, C:17
 dsr (data set ready), I:8, I:10
 dte (data terminal equipment, I:8
 dtr (data terminal ready), I:8, I:10
 dual-port set-up commands, O:5
 dumb modem mode, I:36
 duplex (as an asynchronous command),
 O:5
 DWAIT, C:17, O:15
 ECHO, C:17, O:4, O:43, O:52
 echo, O:5
 eeprom, O:5, I:30
 eh?, C:56, O:3
 enter your message (pbbs), O:22
 EQUALIZE, C:18, I:31
 equalization/calibration, I:31-32
 ESCAPE, C:18
 external reset, I:16
 external scope, I:35
 EXTMODEM, C:18
 FEC, C:18, O:48
 start-up mode, O:6
 fec mode, O:47-49
 figures shift (CTRL-N), O:39
 FILTER, C:18
 flag, O:11
 FLOW, C:19
 flow control
 hardware, O:5, O:19
 software, O:5, O:18
 FRACK, C:19, O:16
 frame, O:11
 front panels, O:7-10
 FSKINV, C:19, O:43
 full duplex, O:5
 FULLDUP, C:19
 GATEWAY, C:20, O:14
 getting out of transparent, O:20
 ground, I:4, I:9, I:16-18
 guard time, O:20
 half duplex, O:5
 hand-held radios, I:23-26
 handshaking (rts/cts), O:5, O:19
 hard reset, O:5, I:30
 hardware flow control, O:5, O:19
 HBAUD, C:20, O:16
 header, O:11
 HEADERLN, C:20, O:13
 HELP (as a command), C:21
 HELP (as a directive), C:51, O:29
 HF, C:21
 hf packet operation, C:20
 HFTONES, C:21
 HID, C:21
 hidden station, O:20
 higher throughput, O:27
 host mode, O:30A-30B
 icom ht radios, I:23
 ID, C:22
 indicators, front panel O:7-10
 in case of difficulty, I:27
 initialize, I:30

interfacing hand-held radios, I:23-26
 interference (rfi) I:3
 INTFACE, C:22
 INVERT, C:22, O:43
 JHEARD, C:52, O:22, O:26, O:29
 jumpers
 afsk output, I:19-21
 equalization, I:31
 rs-232/ttl, I:7
 test/normal (reset), I:30
 watch dog timer, I:33
 K, C:22
 ka-node, C:16, C:51-53, O:25-30
 kanterm program, I:28
 kenwood ht radios, I:23
 kiss mode, C:22, O:35-37
 KM (kill mail), C:52, O:22
 km-2400 modem, I:38
 KNTIMER, C:23, O:28
 LAMTOR, C:23, O:48
 LCOK, C:23
 LCRTTY, C:23, O:43
 LCSTREAM, C:23
 leds, O:7-10
 letters shift (CTRL-L), O:39
 LFADD, C:24
 LIST, C:52
 LLIST, C:24
 LM (list mail), C:52, O:22
 local acknowledgments, higher
 throughput, O:27
 loop back test, I:37
 LOWTONES, C:24, O:43
 mailbox (pbbs), C:16, C:51-52, O:21-23
 renumber msgs, C:36
 status, O:7-10
 MALL, C:24, O:15
 MARK, C:24
 mars call in rtty/ascii, C:30, O:42
 MAXFRAME, C:25, O:16
 MAXUSERS, C:25, O:5, O:6, O:14
 MBEACON, C:25
 mbl, O:6
 MCOM, C:26
 MCON, C:26, O:13, O:15
 messages from the tnc, C:55-60
 messages pbbs, C:52, O:21-23
 MHCLEAR, C:26

MHEARD, C:27, O:22, O:26
 MISSCHAR, C:27, O:47, O:48
 mode A, O:47-49
 mode B, O:47-49
 modem break, O:20
 modem disconnect, I:38
 MODEMENA, C:27, I:36
 MONITOR, C:27, O:12, O:15
 monitoring, O:12
 monitoring (scope), I:35
 MORSE, C:28, O:53
 MRESP, C:29
 MRPT, C:29, O:13
 msk modem, I:38
 MSTAMP, C:29
 multi-connects, O:14
 MYALIAS, C:30, O:13
 MYAUTOST, C:30, O:42
 MYCALL, C:30
 MYGATE, C:30, O:14
 MYNODE, C:30, O:25
 MYPBBS, C:31, O:21
 MYSEL4, C:31, O:47-48
 MYSEL7, C:31, O:47-48
 NAVCLR, C:31
 NAVERR, C:32
 NAVMSG, C:32
 NAVSTA, C:32
 NAVTEX, C:32
 navtex mode, O:50A-50B
 NDHCLEAR, C:32
 NDHEARD, C:33
 NDWILD, C:33, O:25
 NEWMODE, C:33
 NODES, C:53, O:26, O:30
 NOMODE, C:33, O:13
 NTEXT, C:34
 NUCR, C:34
 NULF, C:34
 NUMNODES, C:34, O:25
 ONERADIO, C:34
 packet mode, O:11-20
 PACLEN, C:35, O:13, O:16
 PACTIME, C:35
 panels
 back, I:5
 front, O:7-10

4 INDEX

Version 3.0 Aug. 13, 1990

© Copyright 1989, 1990, Kantronics, Inc. All Rights Reserved.
 Duplication of this manual or the firmware without
 permission of Kantronics, Inc. is prohibited.

parameter types, C:2-4
 n (range), C:2
 n (\$00 - \$FF), C:2
 flags, C:3
 callsigns, C:3
 test, C:3
 dual-port, C:4
 PARITY, C:35, O:4
 parity, O:4, I:7
 PASS, C:35
 PASSALL, C:36
 PBBS, C:36, O:21
 pbbs, C:16, C:51-52, O:21-23
 renumber msgs, C:36
 status, O:7-10
 PBPERSON, C:36
 pcjr, I:11
 performing a loop-back test, I:37
 PERM, C:36, O:5
 PERSIST, C:37, O:15, O:35
 personal mailbox (pbbs), C:16, C:51-52,
 O:21-23
 PID, C:37
 PMODE, C:37, O:6
 poll, O:16, O:17
 PORT, C:38, O:5
 POSTKEY, C:38
 power requirements, I:45
 precautions, I:4
 PREKEY, C:38
 programs
 computer, O:4, I:7
 host, O:30A-30B
 sample, O:41-43
 split-screen, O:5
 terminal, O:4, I:7
 wefax, O:31, O:33-34
 PROSIGN, C:38, O:51
 protocol, O:3, O:11
 PTEXT, C:38
 qpsk, I:38
 radio connections, I:15-18
 hand-held, I:23-26
 radio frequency interference, I:3
 radio shack color computer, I:12
 RBAUD, C:38A, O:40, O:43
 READ n (pbbs), C:52, O:22
 rear panels, I:5
 receive data (rxd), O:18, I:8-9
 RECONNED, C:38A
 REDISPLAY, C:38A
 RELINK, C:39, O:17
 repair procedures, I:2
 REPHASE, C:39
 request to send (rts), O:5, O:19, I:8, I:10
 RESET, C:39
 reset
 external, I:16
 hard, O:5, I:30
 RESPTIME, C:39
 RESTORE, C:40
 retries ax.25 level 2, version 1 vs.
 version 2, O:17
 RETRY, C:40, O:11
 return/repair, I:2
 reverse forwarding, O:23
 rfi, I:3
 RING, C:40
 rli, O:6
 RM (read mail), C:52, O:22
 RNRTIME, C:40
 round table discussions, O:12, O:15
 rs-232
 jumper, I:7
 precautions, I:4
 wiring, I:8-10
 rts (request to send), O:5, O:19, I:8, I:10
 rts/cts handshaking, O:5, O:19
 RTTY, C:40
 directives, O:45
 start-up mode, O:6
 rtty mode, O:39-45
 rxd (receive data), O:18, I:9
 sample terminal programs, I:41
 save parameters, C:36
 scope monitoring, I:10, I:35
 SCREENL, C:41
 seizing link (amtpr), O:49
 selcal, C:31, O:47
 selective fec, O:47
 selfec, O:47
 SEND (pbbs message), C:52, O:22
 SENDPAC, C:41, O:13
 serial port, I:7
 set-up
 dual-port commands, O:5

service, I:2
 sg (signal ground), I:8-9
 SHIFT, C:41
 signal ground (sg), I:8-9
 SLOTTIME, C:41, O:15, O:35
 software carrier detect (radio), C:10A
 software flow control, O:5, O:18
 SPACE, C:41
 specifications, I:45
 START, C:41, O:5, O:18
 STATSHRT, C:42, O:15
 STATUS, C:42, O:15
 stay option (ka-node), C:51, O:25
 STOP, C:42, O:5, O:18
 stop bits, O:4, I:7
 STREAMCA, C:42, O:15
 STREAMEV, C:43, O:15
 STREAMSW, C:43, O:14
 subject line (pbbs), O:22
 SUPCALLS, C:43
 SUPLIST, C:43
 SWDETLED, C:44
 modification, I:39
 SWP, C:44
 tcp/ip, O:35-37
 technical specifications, I:45
 terminal program
 host, O:30A-30B
 parameters, O:4, I:7
 samples, I:41-43
 split-screen, O:5
 wefax, O:31, O:33-34
 test
 in case of difficulty, I:27-28
 loop back, I:37
 test/normal jumper, I:30
 time (of day), C:15
 timing (packet), O:15-16
 trouble, I:27-28
 tnc
 computer connection, I:7
 definition, O:3
 radio connection, I:15
 TRACE, C:44
 TRANS, C:44
 transmit data (txd), O:18, I:8-9

transparent mode, O:19
 getting out, O:20
 using software flow control, O:18
 TRFLOW, C:45, O:18
 TRIES, C:45
 trs model 100, I:12
 trs-80 model III sample program, I:42
 ttl jumper, I:7
 tuning
 amtor, O:50
 cw, O:51
 rtty/ascii, O:41
 txd (transmit data), O:18, I:8-9
 TXDAMTOR, C:45, O:48
 TXDELAY, C:45, O:16
 TXDFEC, C:46
 TXFLOW, C:46, O:18
 unattended operation, I:33-34
 unconnected, O:11
 UNPROTO, C:46, O:12, O:14
 unproto mode, O:11, O:12, O:15
 upgrading, I:30
 USERS, C:47, O:14
 using a ka-node, O:26
 USOS, C:47, O:39, O:43
 via, O:13
 warranty, I:1
 watch dog timer, I:33-34
 WEFAX, C:47, O:33
 Wefax Mode, O:31-34
 tuning, O:8, O:32
 writing a program, O:33
 wiring
 to computer, I:8
 word length, O:4, I:7
 wru, O:49
 WTEXT, C:47, O:49
 XCONNECT, C:53, O:28, O:30
 XFLOW, C:47, O:4, O:5, O:18
 XMITECHO, C:48, O:43, O:52
 XMITOK, C:48
 XOFF, C:48, O:5, O:18
 XON, C:48, O:5, O:18
 y-connector, I:16-17
 yaesu ht radios, I:23
 zenith-100 sample program, I:43

Pactor Option Addendum

KAM Eprom Version 6.1

Thank you for purchasing the Pactor Option for your KAM. We believe you'll find many hours of enjoyment and many new friends as you explore this new digital mode.

The enclosed Eprom for your KAM contains some minor changes since the original release, version 6.0. The manual indicates (on pages 3 and 10) that you must use the PTLISTEN mode to monitor Pactor transmissions. By popular demand, this has been changed in version 6.1 to allow monitoring in Standby mode too.

To monitor Pactor in Standby mode, set the MONITOR command to ON/XXX and the ARQBBS command to OFF. In Pactor Standby mode, you can also transmit FEC by typing <CTRL-C>T and return to receive by typing <CTRL-C>E.

We've also added the NAVLOG command, an immediate command, to display a list of NAVTEX messages that have been properly received in the NAVTEX mode.

March 22, 1993 KAM 6.1

© Copyright 1993, Kantronics Co., Inc. All Rights Reserved.
Duplication of this manual or the firmware without permission of Kantronics Co., Inc. is prohibited.

R37 - 15K
 R38 - 10K MF
 R39 - 33K
 R40 - 9.1K
 R41 - 8.45K MF
 R42 - 2.7K
 R43 - 22K
 R44 - 10K
 R45 - 680K
 R46 - 620K
 R47 - 220K
 R48 - 10K
 R49 - 5.1K
 R50 - 15K
 R51 - 9.53K MF
 R52 - 82K
 R53 - 220K
 R54 - 100K
 R55 - 150K
 R56 - 150K
 R57 - 150K
 R58 - 33K
 R59 - 33K
 R60 - 2.7K
 R61 - 1.2K
 R62 - 15K
 R63 - 5.1K
 R64 - 82K
 R65 - 9.53K MF
 R66 - 68K
 R67 - 47K
 R68 - 100K
 R69 - 150K
 R70 - 22K
 R71 - 68K
 R72 - 100K
 R73 - 100K
 R74 - 1M
 R75 - 220
 R76 - 180K
 R77 - 100K
 R78 - 100K
 R79 - 100K
 R80 - 2.2K
 R81 - 22K
 R82 - 2.2K
 R83 - 100K
 R84 - 9.1K
 R85 - 100K
 R86 - 2.2K
 R87 - 220
 R88 - 220

 R90 - 620
 R91 - 1M

R92 - 2.2K
 R93 - 1K
 R94 - 2.2K
 R95 - 10K
 R96 - 100K
 R97 - 6.8K
 R98 - 100K
 R99 - 33K
 R100 - 1K
 R101 - 1K
 R102 - 10K
 R103 - 100K
 R104 - 51K
 R105 - 10K
 R106 - 6.8K
 R107 - 100
 R108 - 100K
 R109 - 120K
 R110 - 270
 R111 - 270
 R112 - 6.8K
 R113 - 270

RFC1 - 10uh

S1 - PUSH PUSH
 S2 - PUSH PUSH

U1 - MC34074
 U2 - 74HC04
 U3 - 4018
 U4 - MF4CN
 U5 - TCM3105
 U6 - MF10CN
 U7 - LM339
 U8 - MF10CN
 U9 - MF10CN
 U10 - MF4CN
 U11 - LM324
 U12 - MF10CN
 U13 - LM358
 U14 - 4066
 U15 - 4069
 U16 - LM3914
 U17 - 74HC259
 U18 - 74HC10
 U19 - 74HC04
 U20 - SPARE
 U21 - 42832
 U22 - 27C256
 U23 - 71054
 U24 - SPARE
 U25 - X2404
 U26 - 63B03X
 U27 - 4070

U28 - MC34074
 U29 - LM358
 U30 - LM339

VR1 - 78M05 +5v Reg
 VR2 - 79L05 -5v Reg

RN1 - 10K
 RN2 - 10K
 RN3 - 10K
 RN4 - 10K
 RN5 - 10K
 RN6 - 220K
 RN7 - 100K
 RN8 - 10K

KAM PARTS LIST

Version 2.85
 Installation Manual

© Copyright 1989, Kantronics, Inc. All Rights Reserved.
 Duplication of this manual or the firmware without
 permission of Kantronics, Inc. is prohibited.